

uno

Dibuje 1(un) elemento:

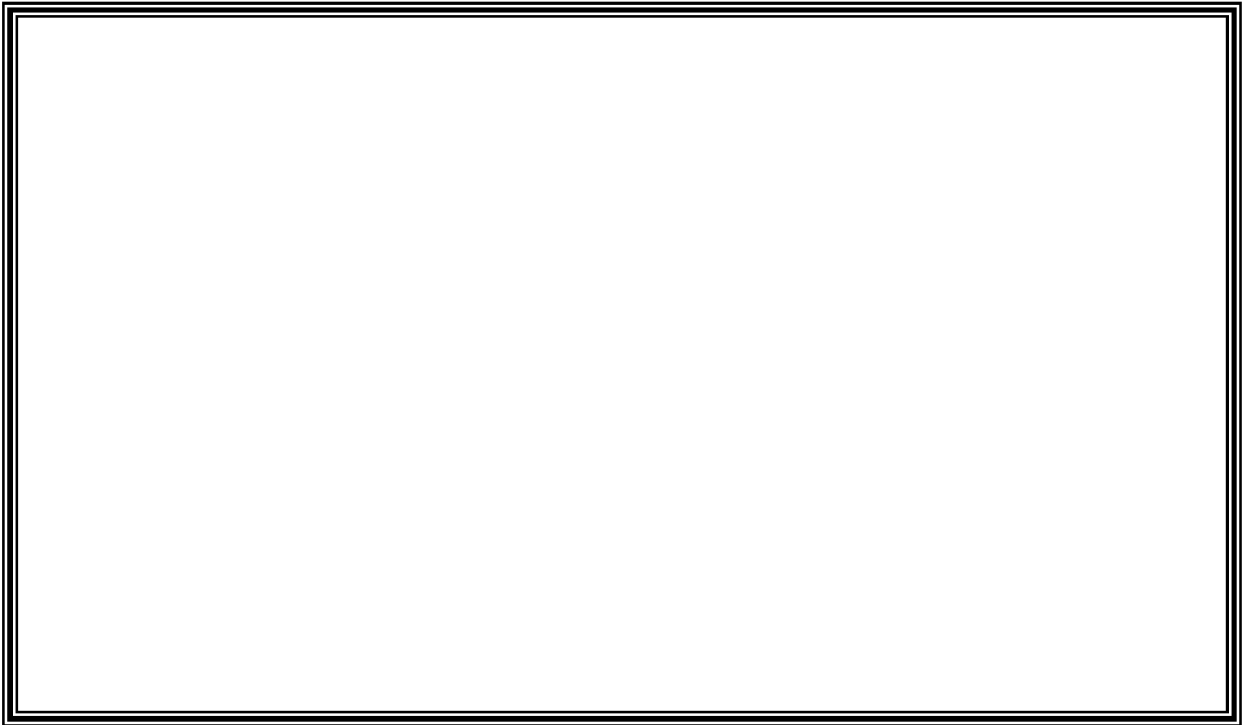

Repase con el dedo índice 3 veces el número 1:

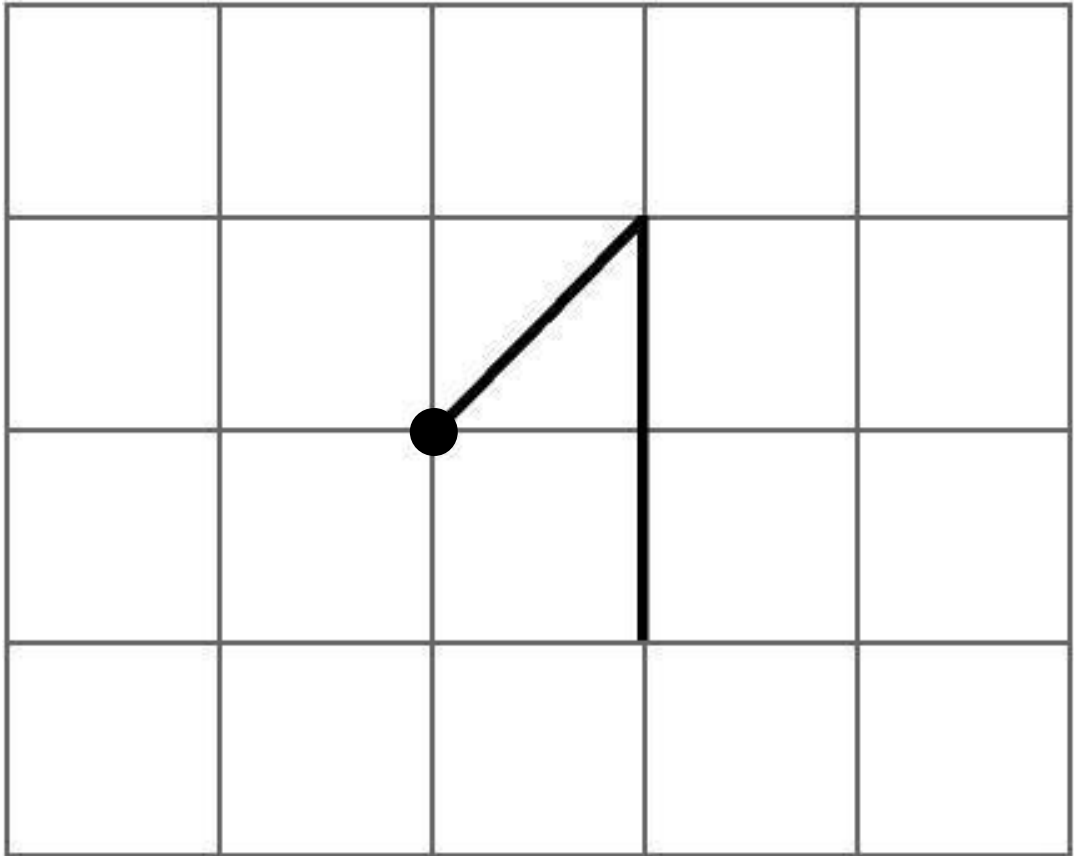

Ahora escríbalo.

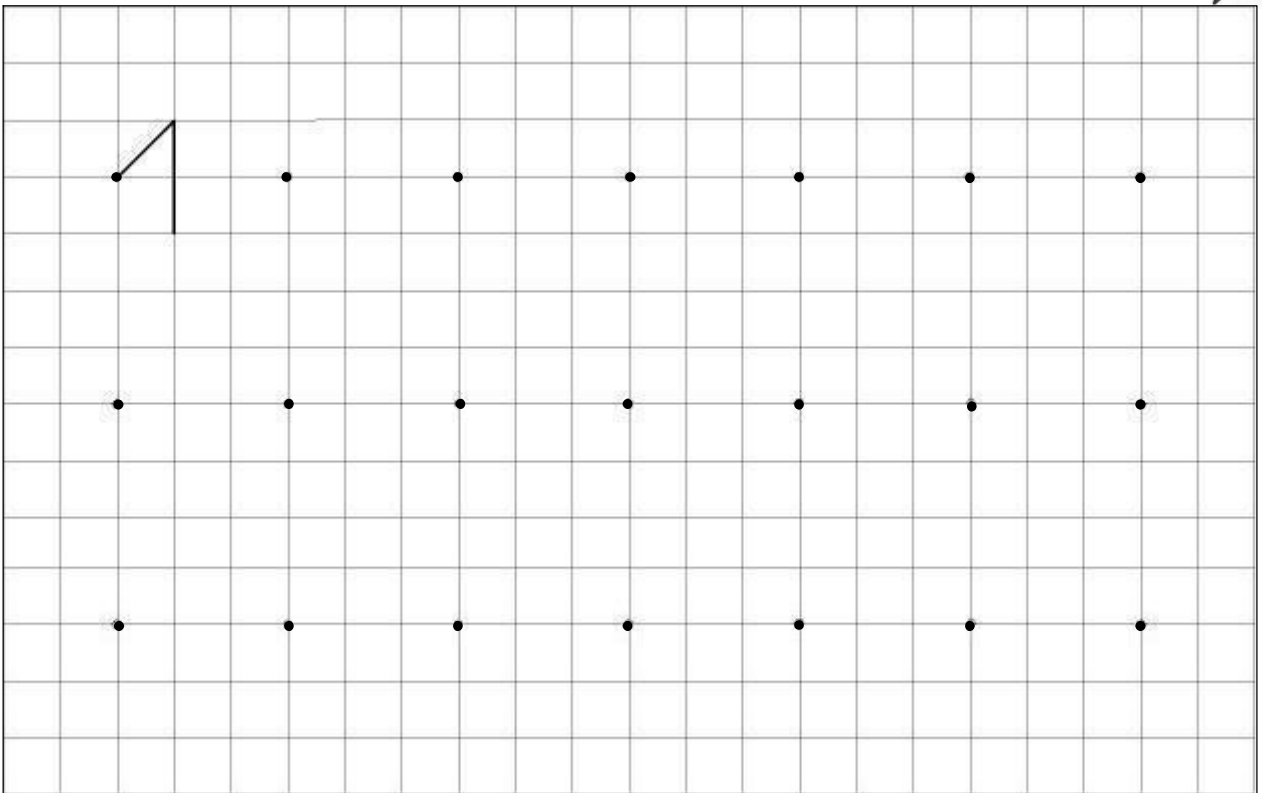

Sopa de números

Encierre en un círculo azul los números 1:

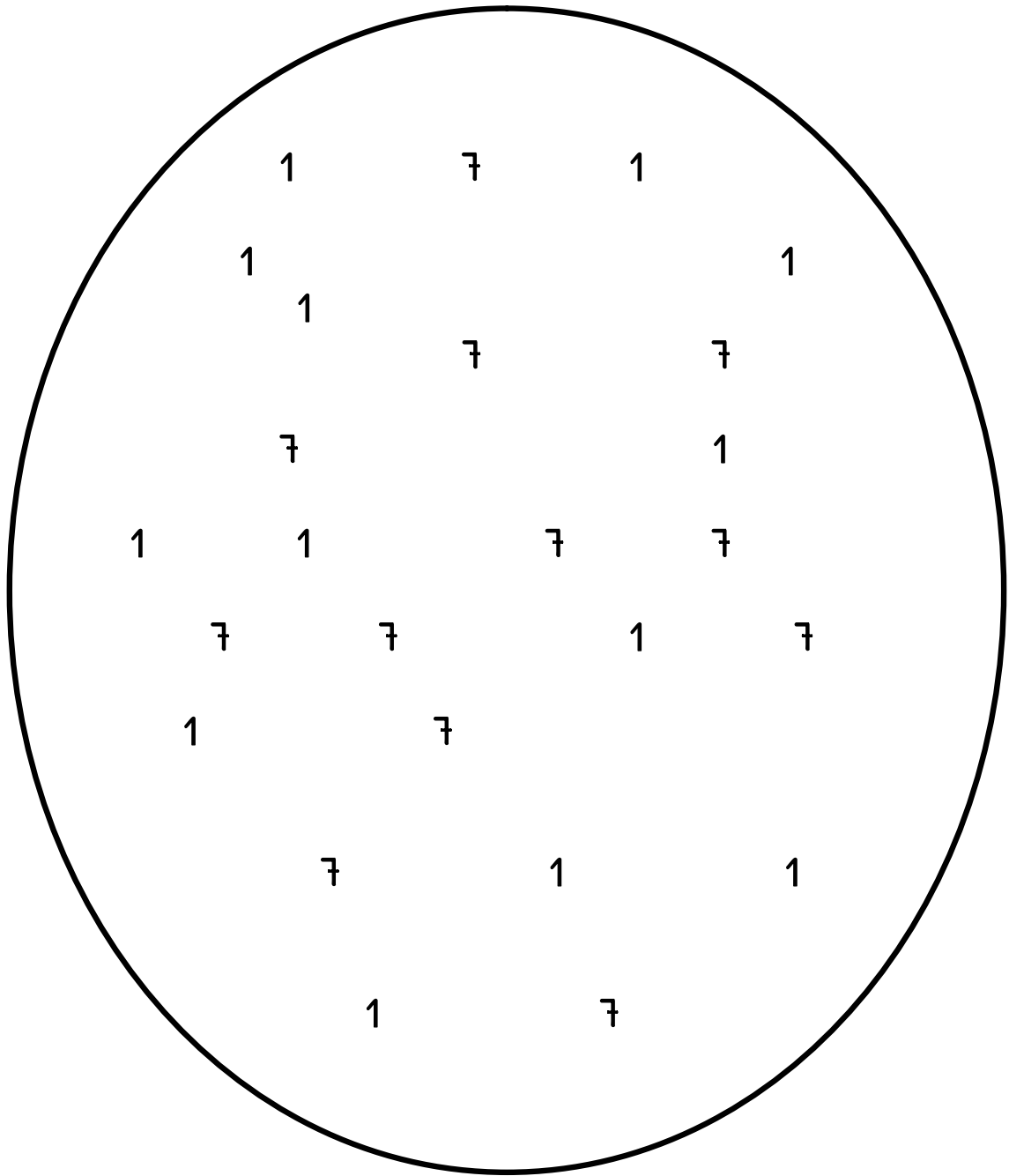

Marque con una cruz todos los conjuntos que tienen 1 verdura:

●	X
---	---

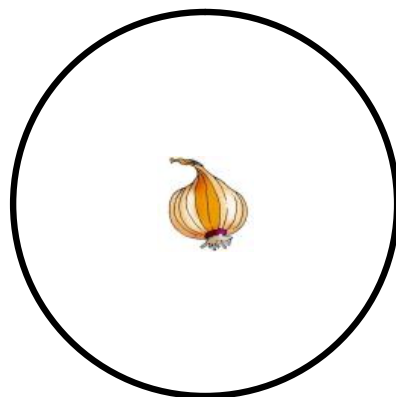
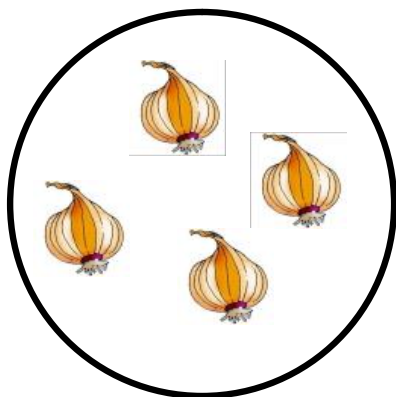
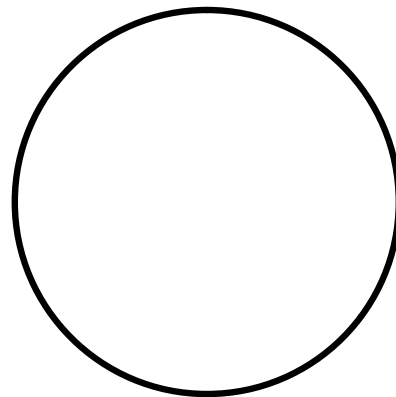
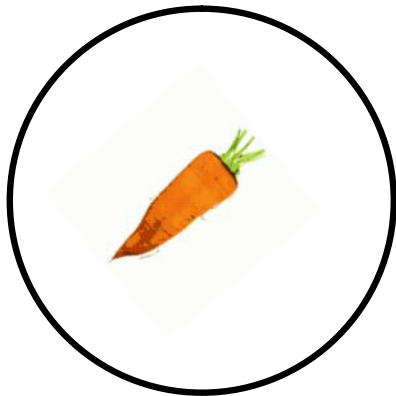
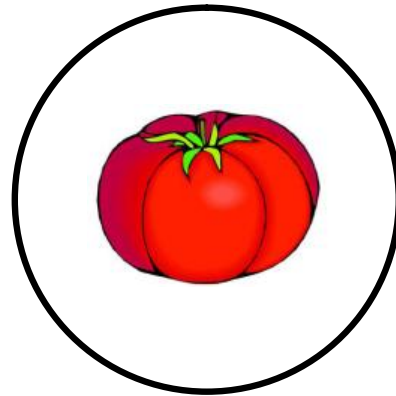
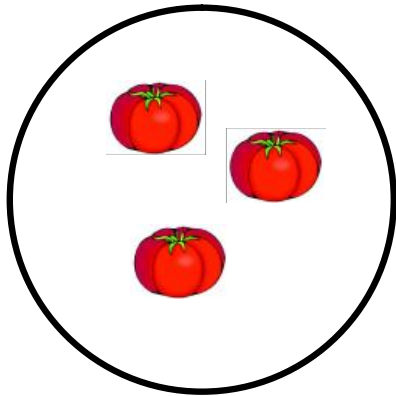

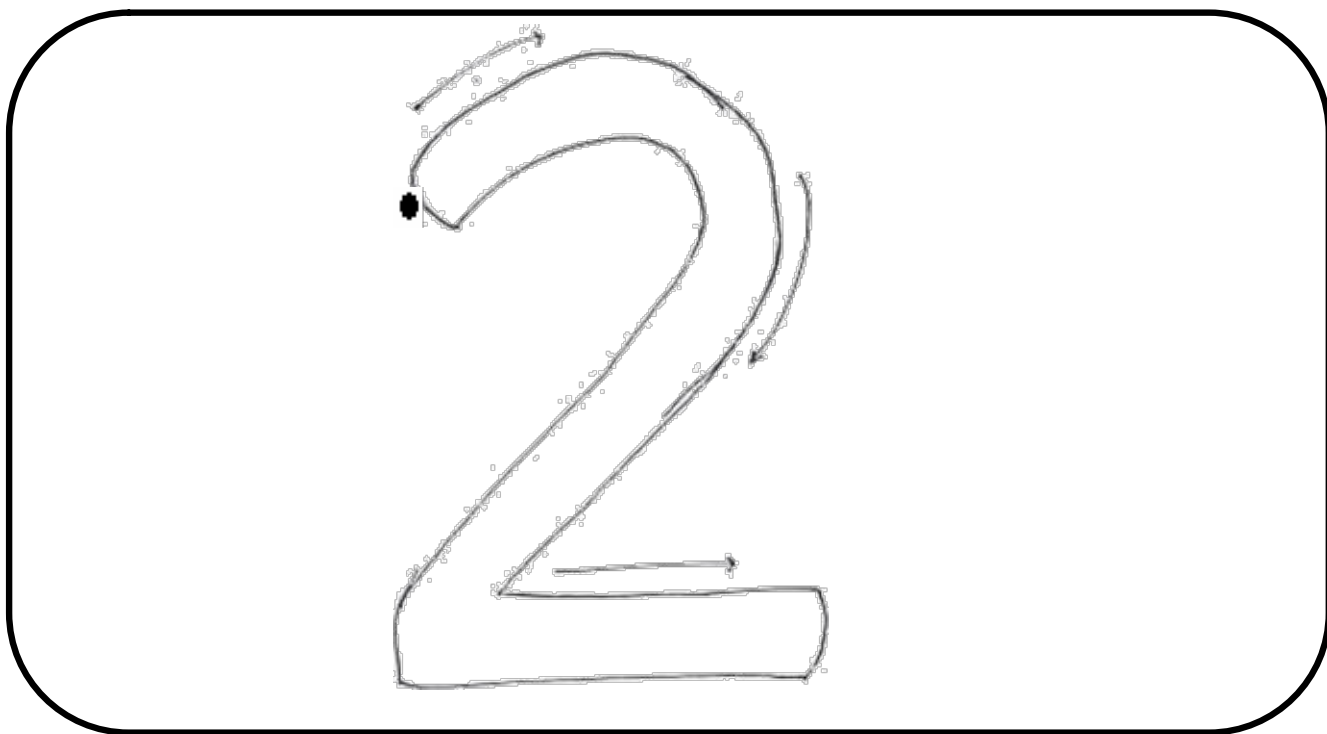

dos

Dibuje 2 (dos) elementos



Repase con el dedo índice 3 veces el número 2:

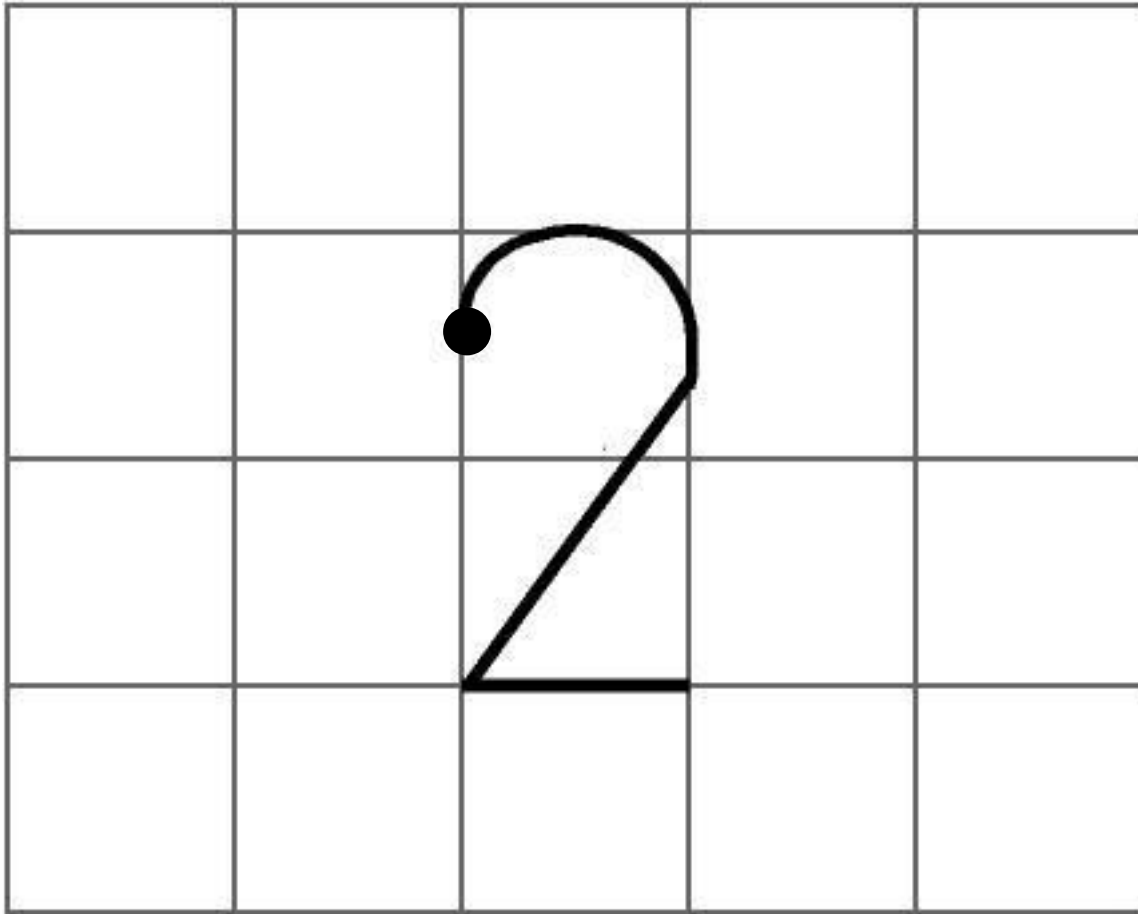

Ahora escríbalo.

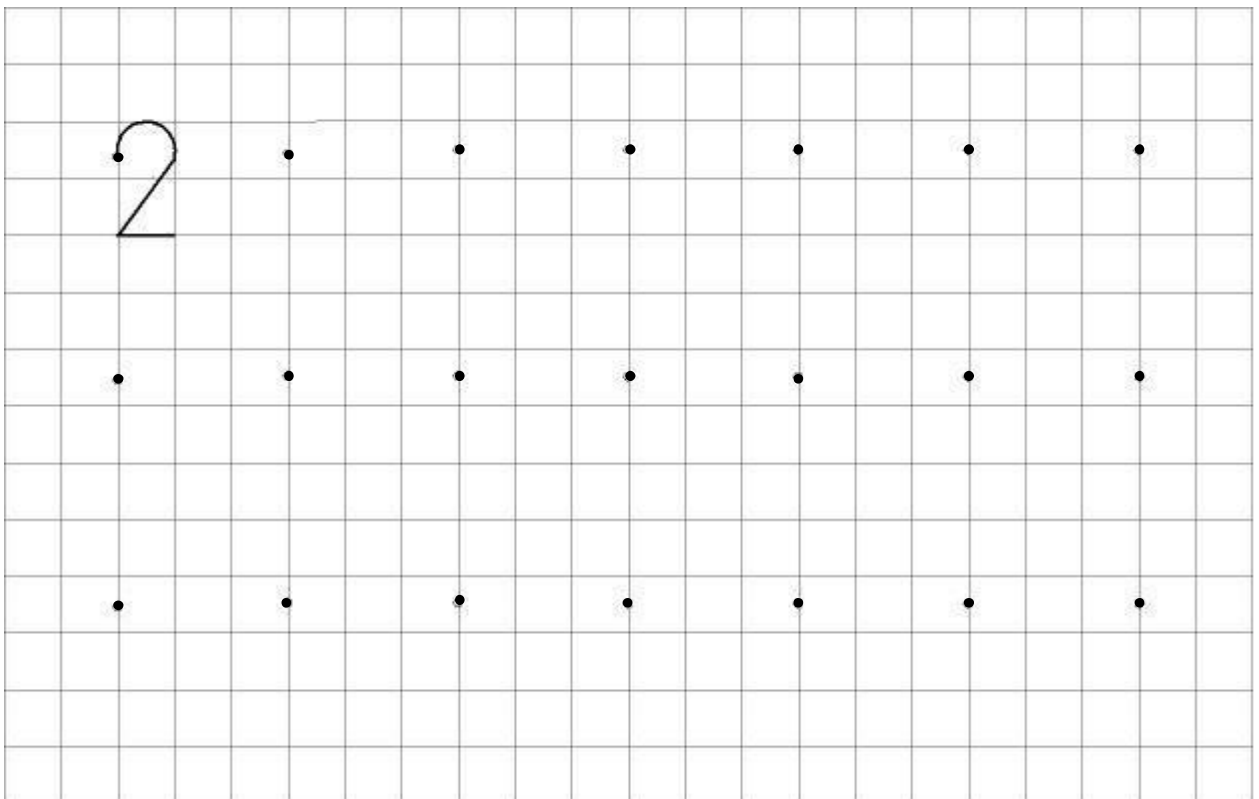

Sopa de números

Marque con una cruz los números 2:

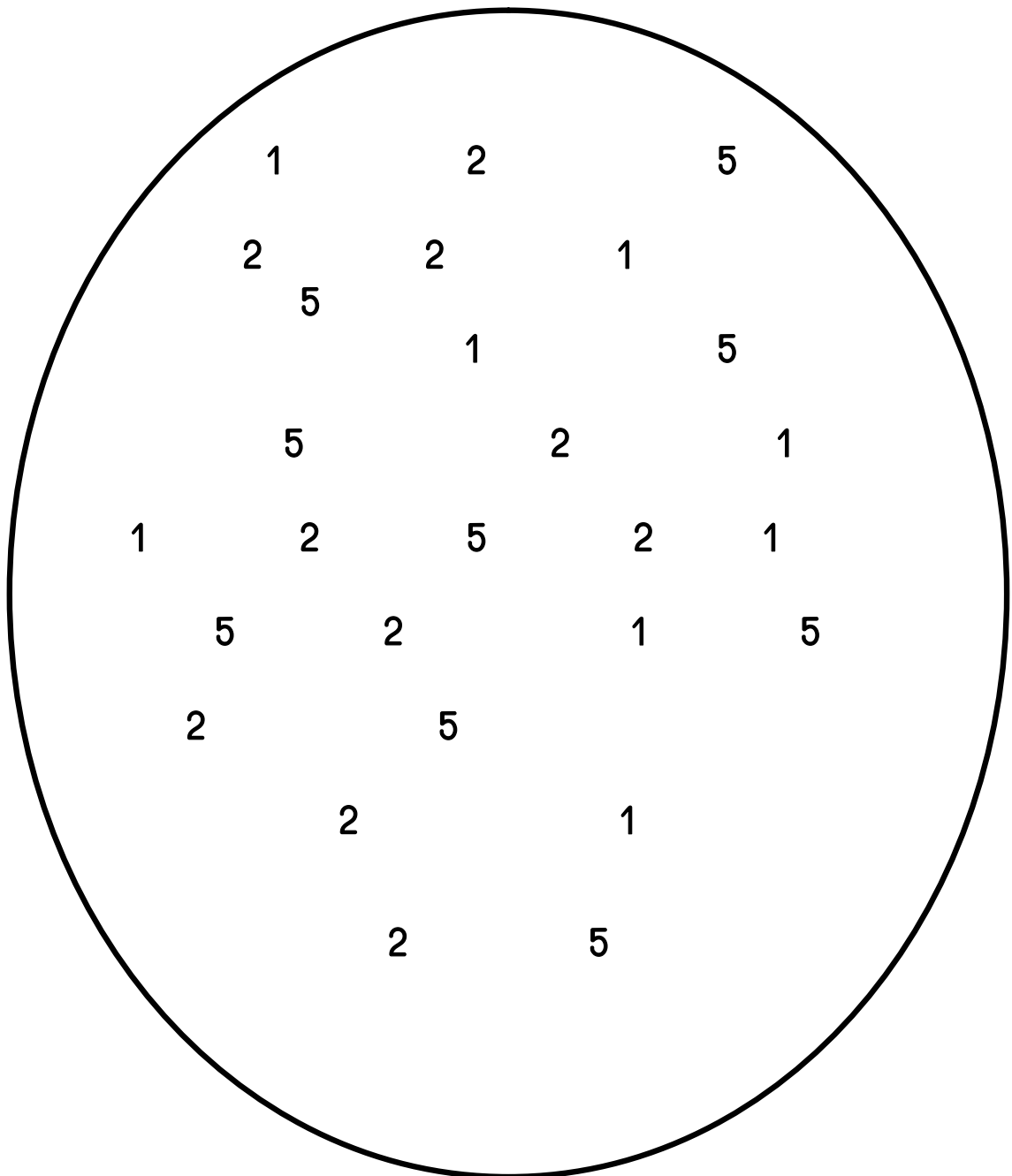

Una la cantidad de instrumentos que corresponde a cada número:

2

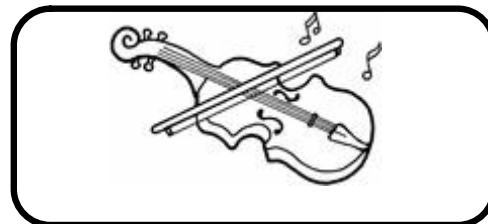
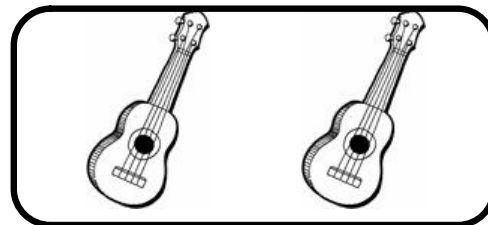

1

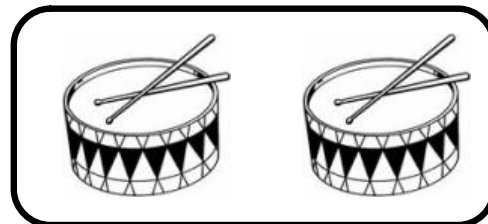

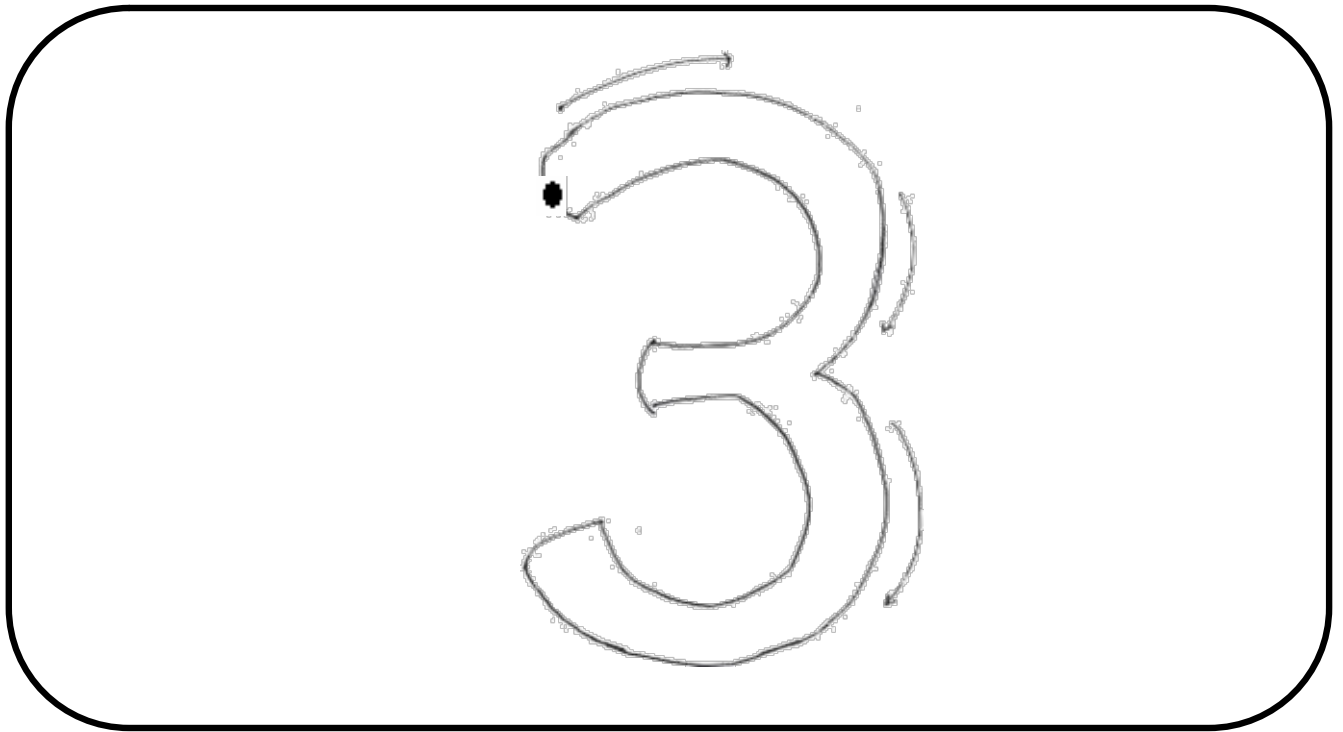

tres

Dibuje 3 (tres) objetos:

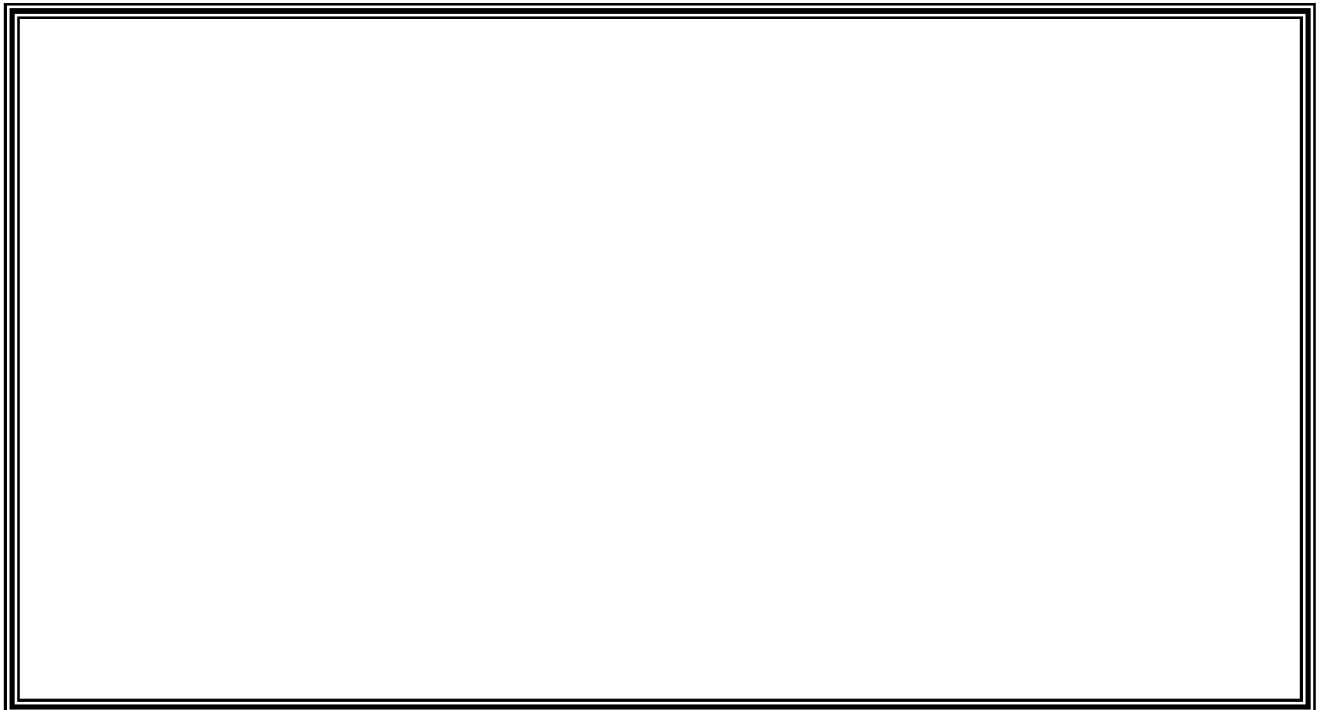

Repase con el dedo índice 3 veces el número 3:

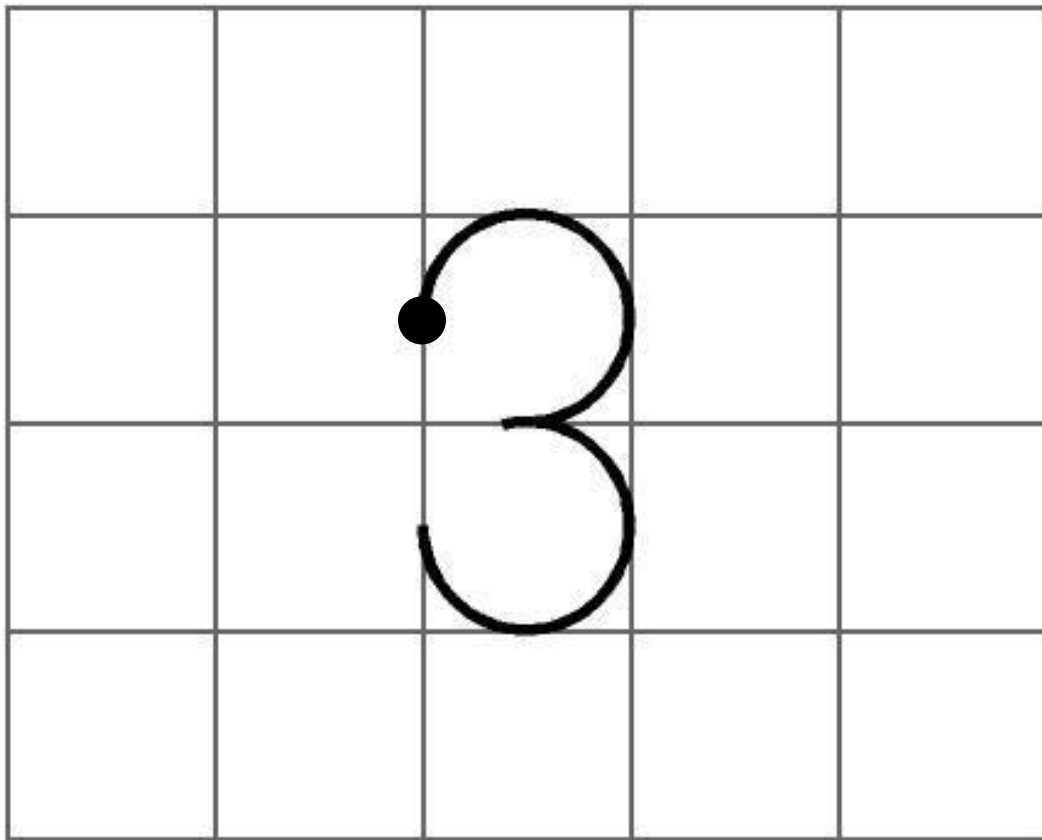

Ahora escríbalo.

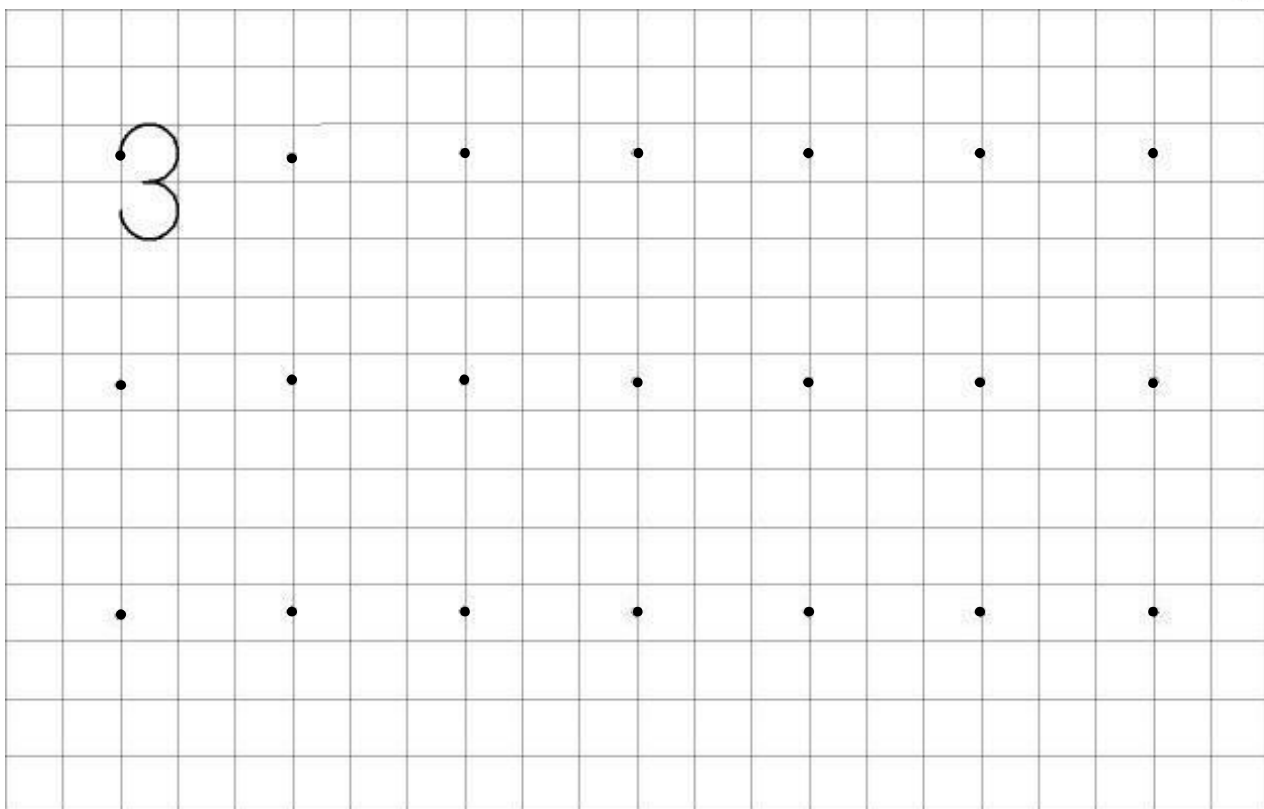

Sopa de números

Encierre en un círculo rojo los números 3:

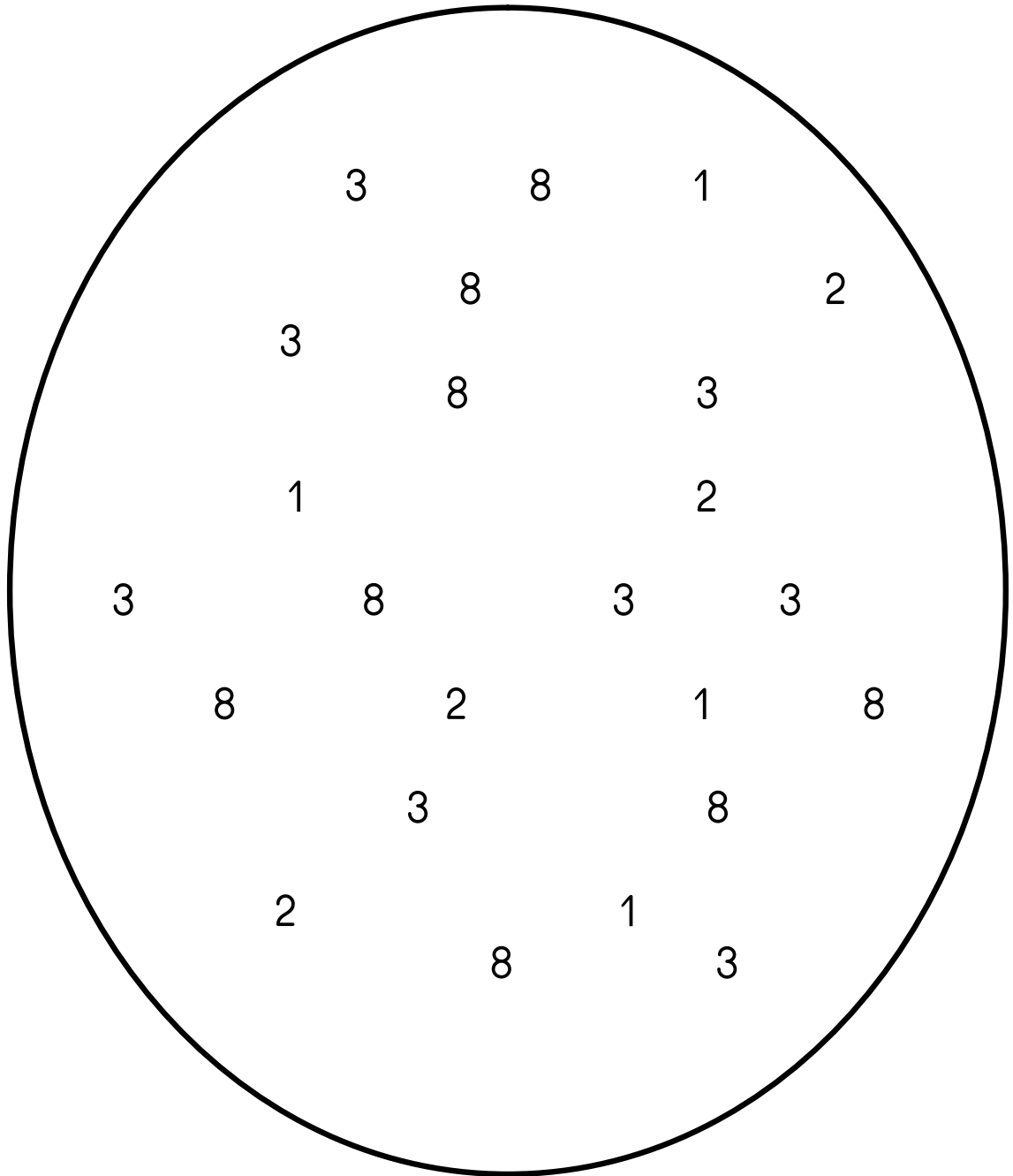

Marca con una cruz todos los conjuntos donde hay 3 (tres) medios de transporte:

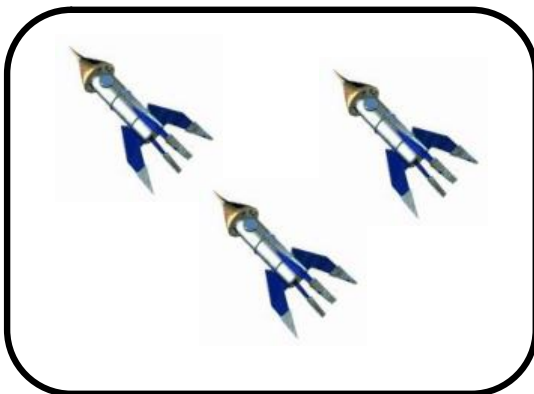
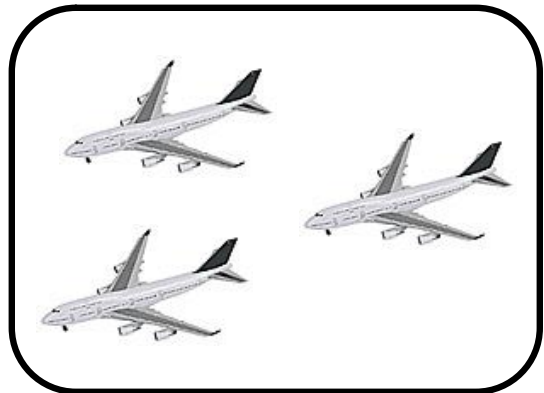
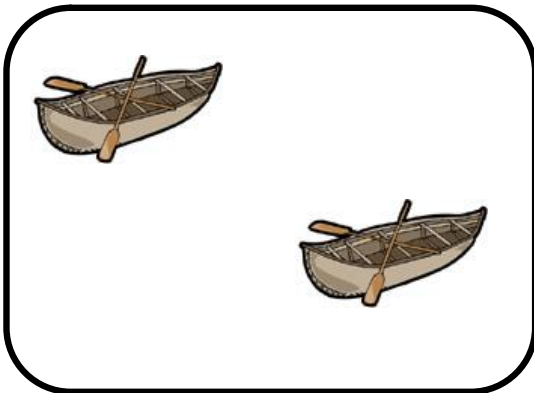
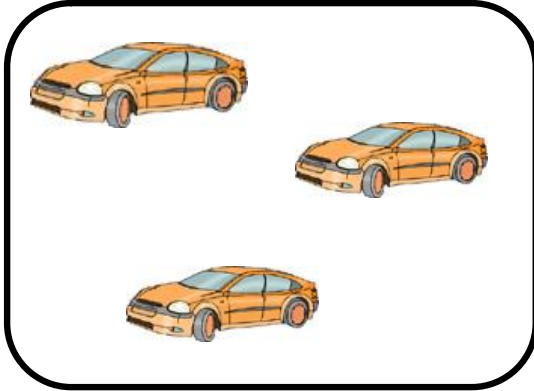
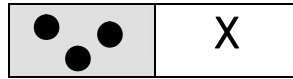

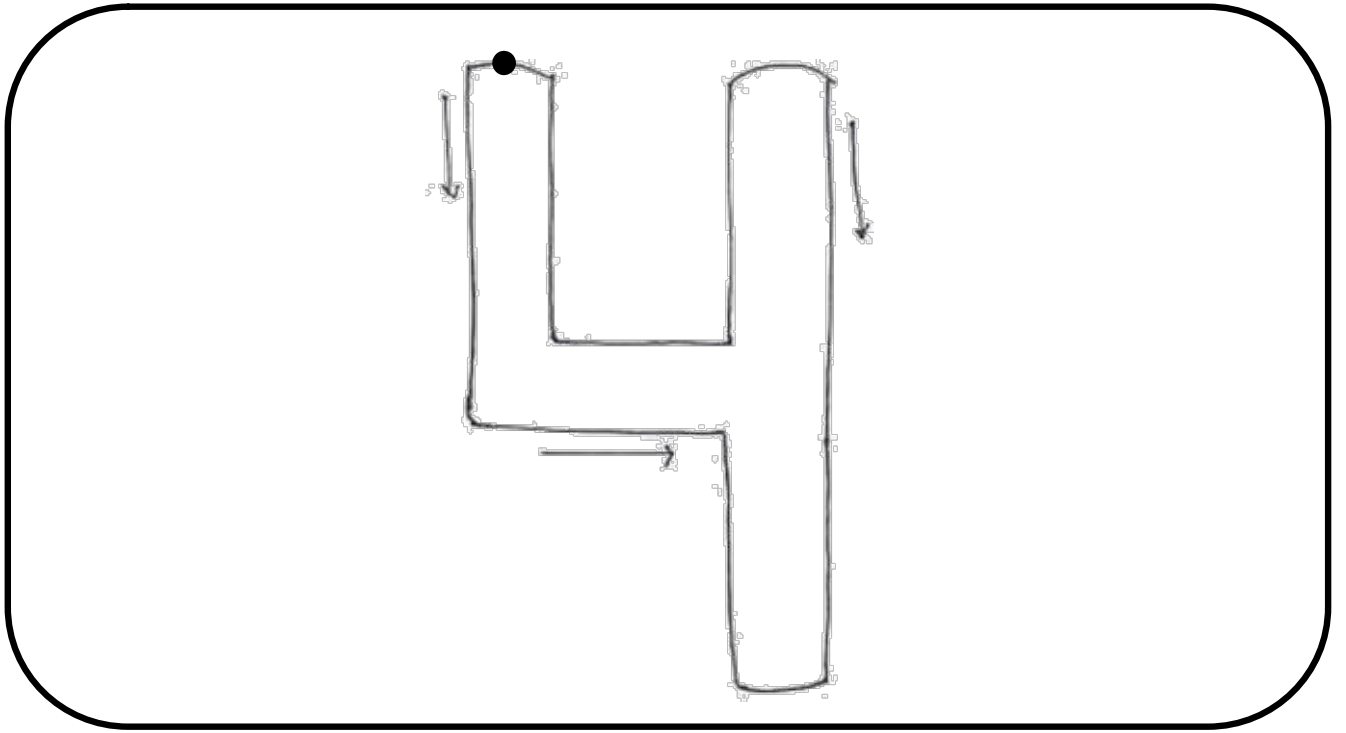

cuatro

Dibuje 4 (cuatro) objetos:

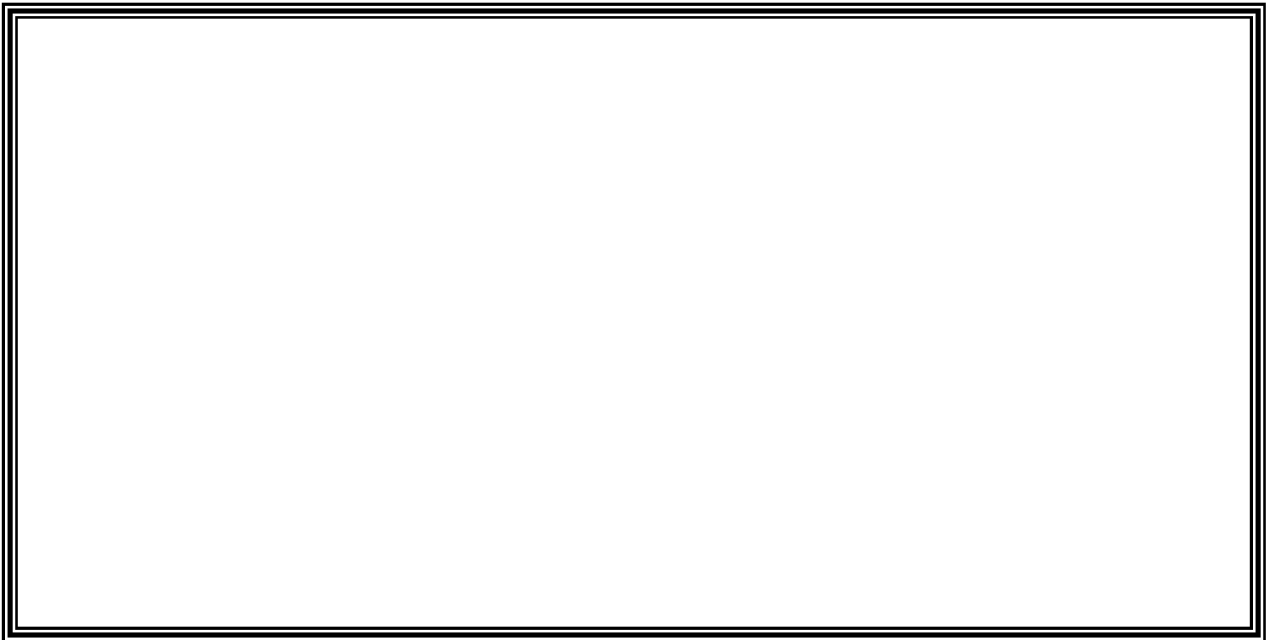

Repase con el dedo índice 3 veces el número 4:

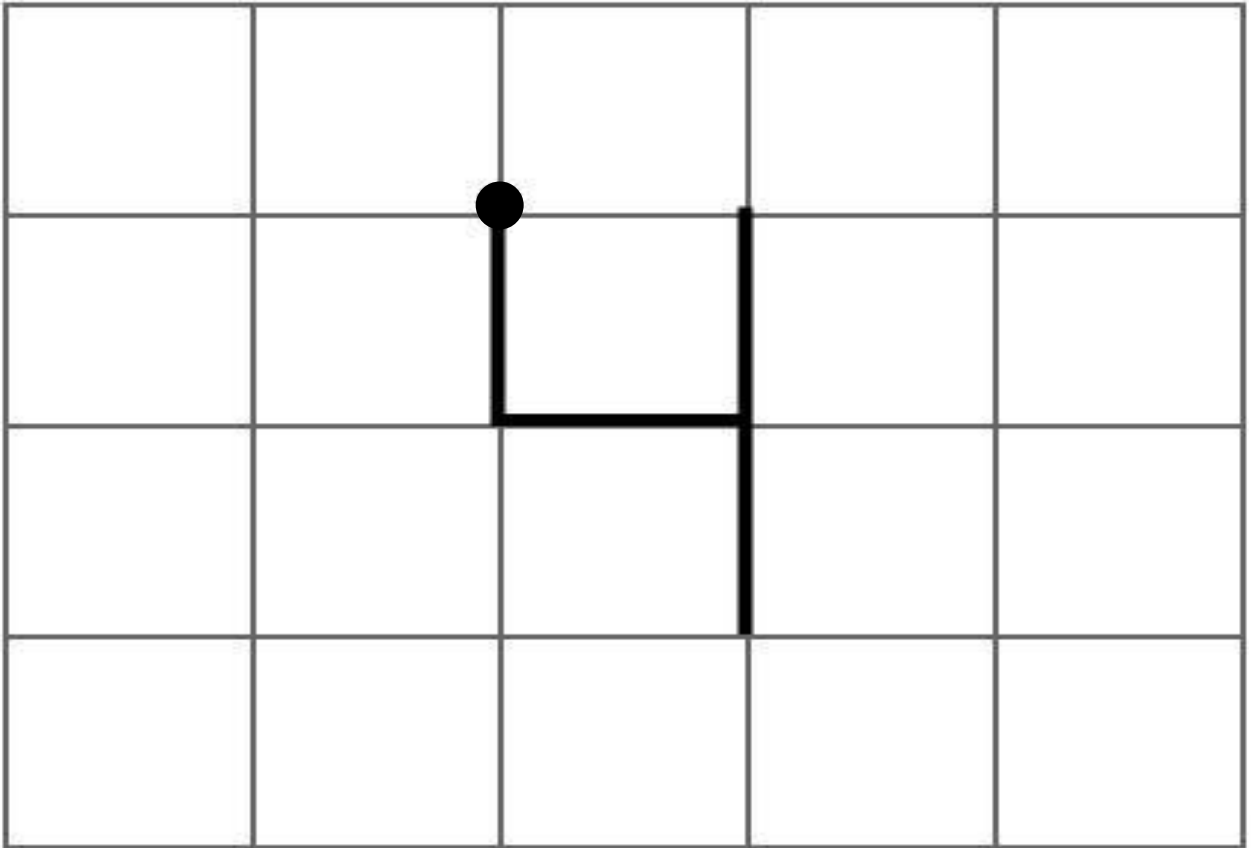

Ahora escríbalo.

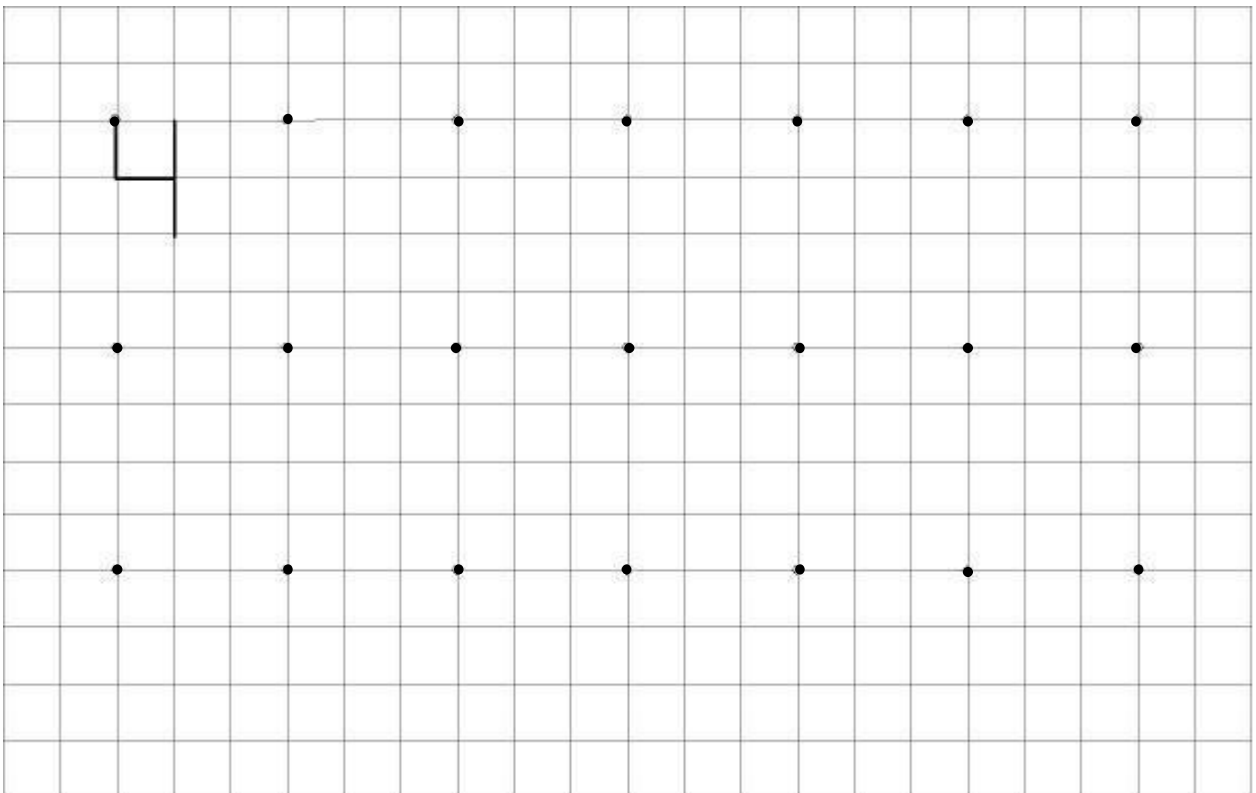

Sopa de números

Subraye los números 4:

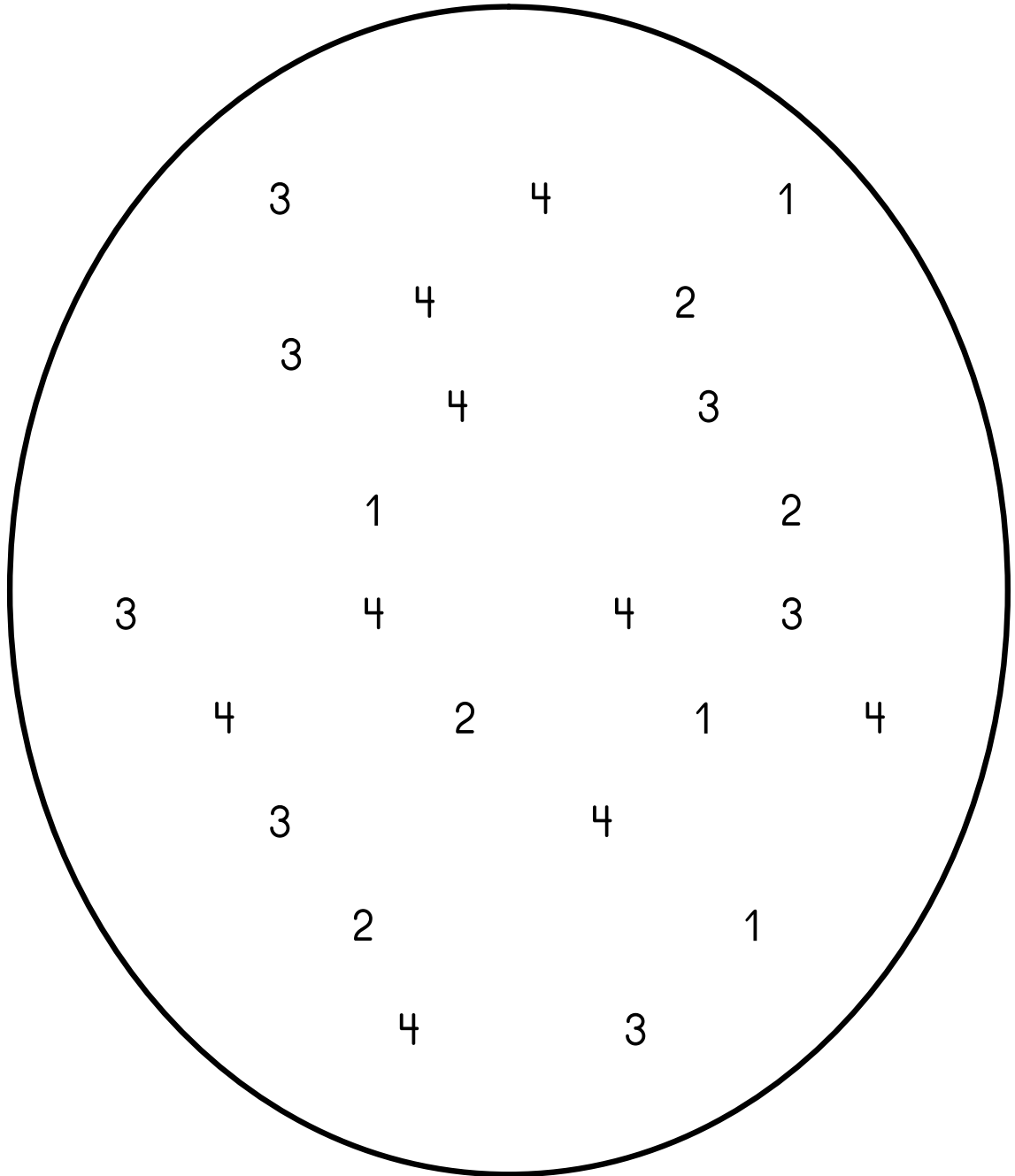

Escribe en número que corresponde a la cantidad de animales que hay en cada conjunto:

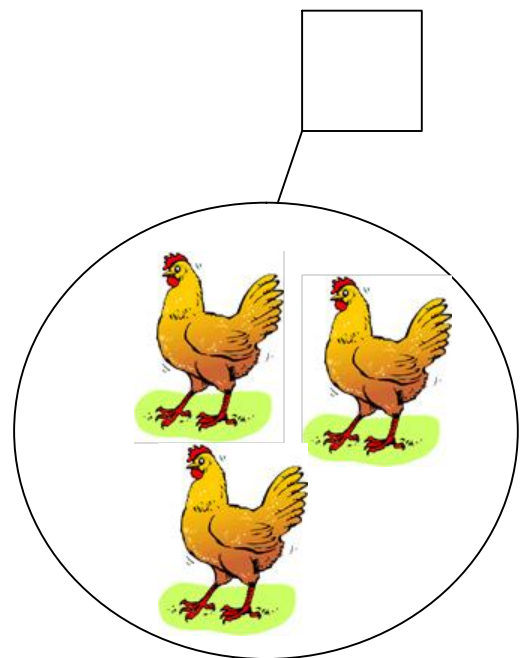
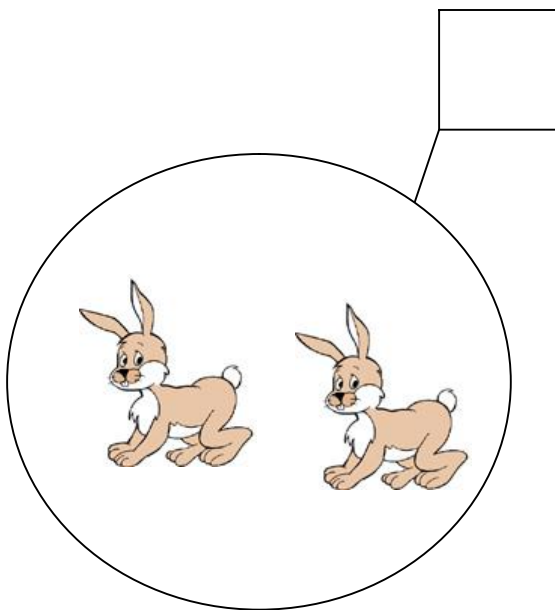
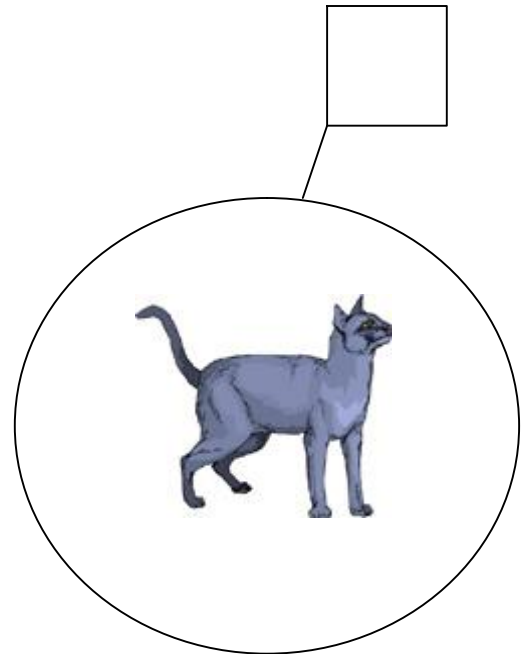
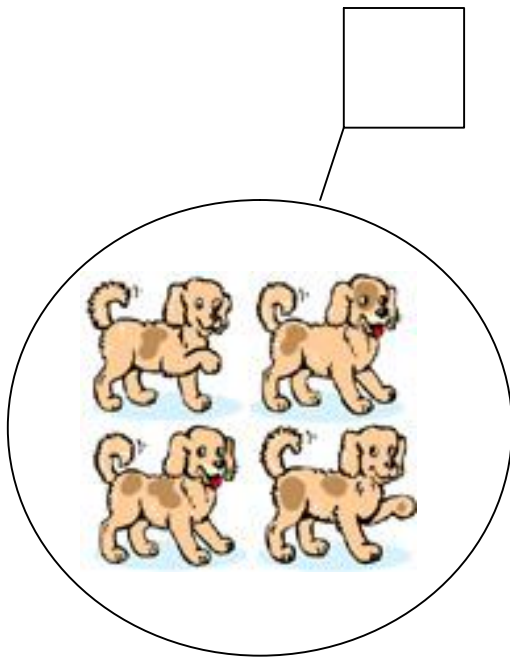

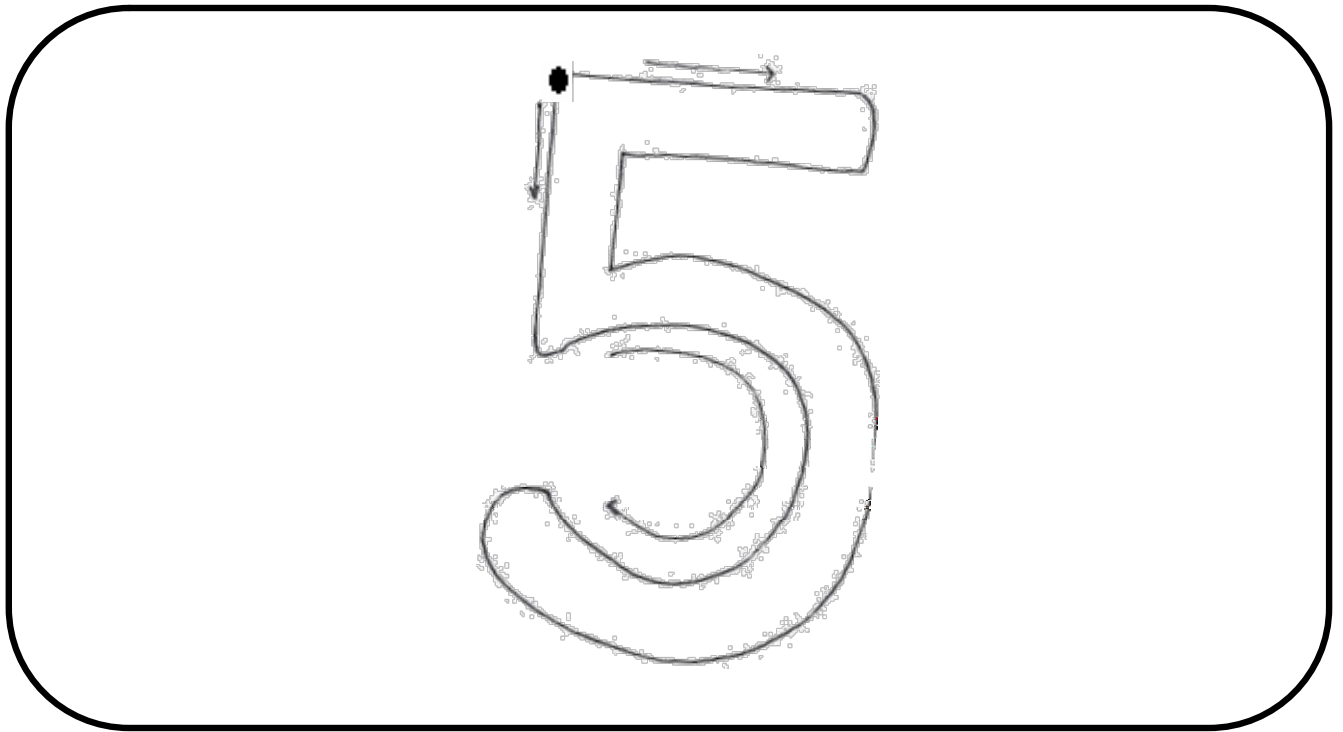

cinco

Dibuje 5 (cinco) objetos:



Repase con el dedo índice 3 veces el número 5:

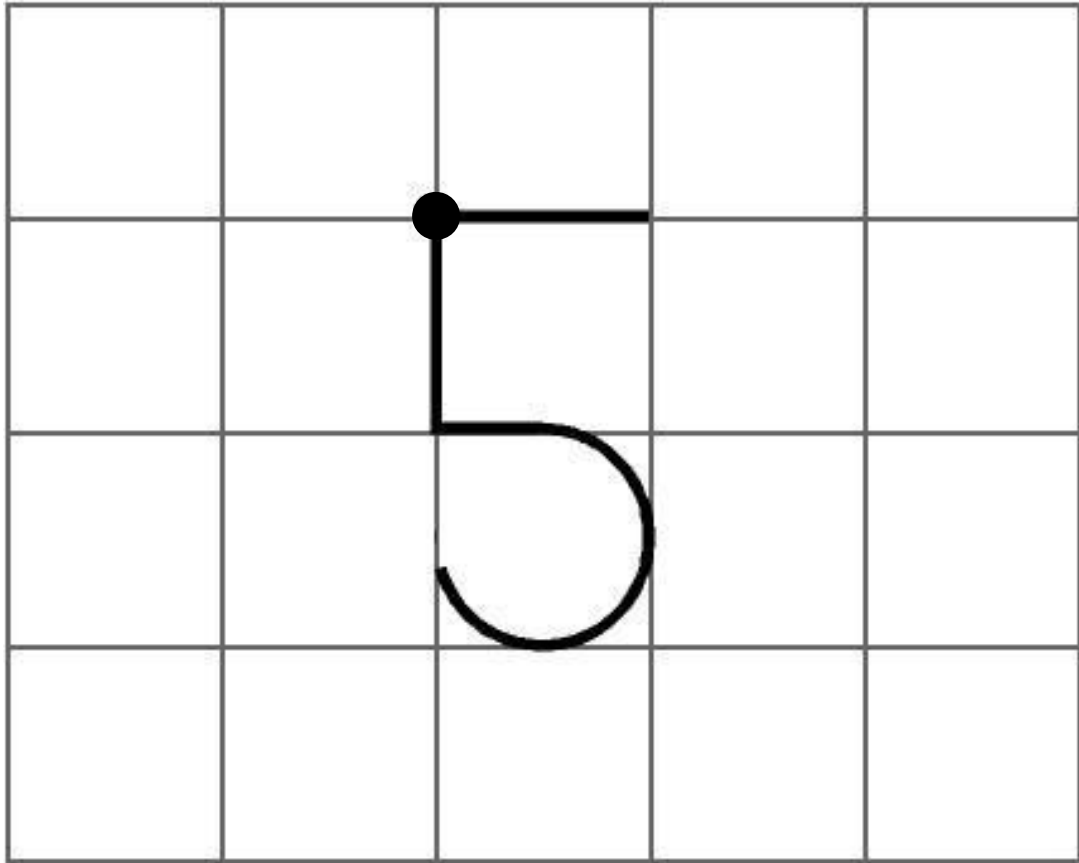

Ahora escríbalo.

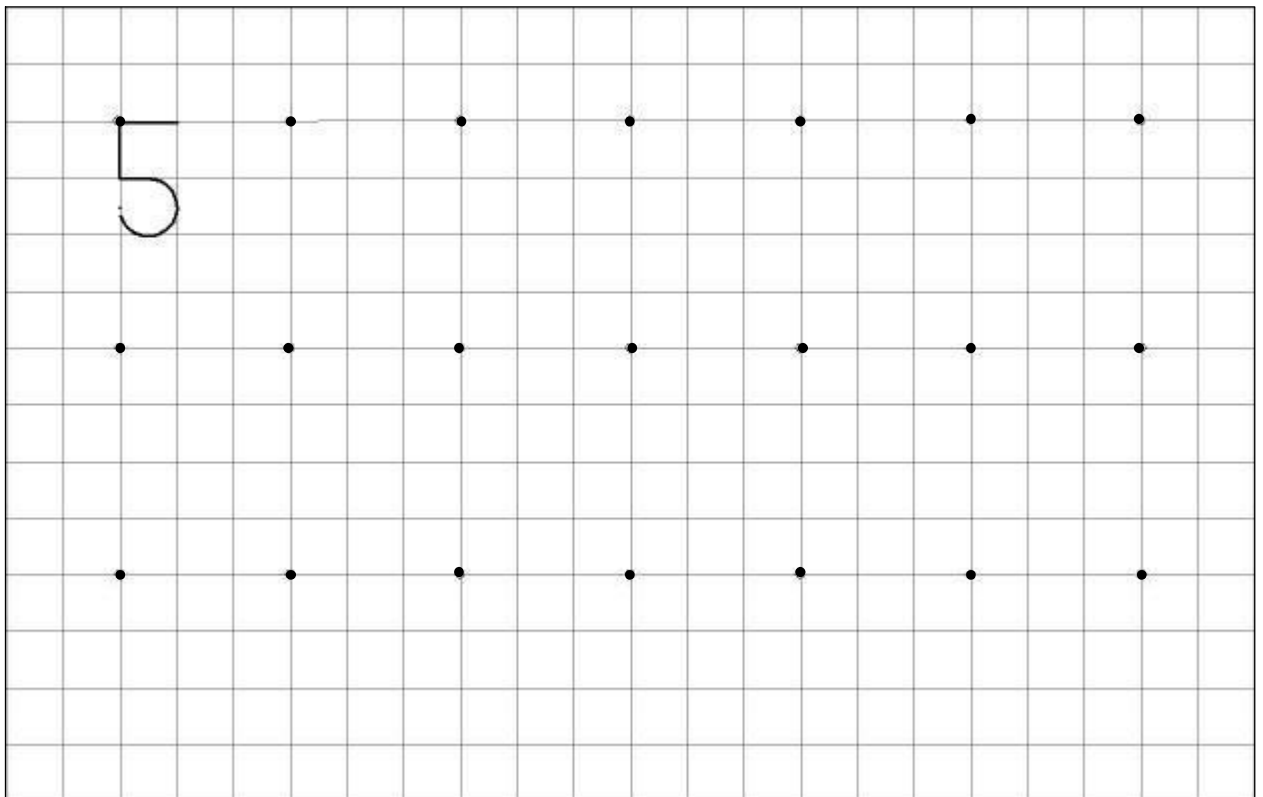

Sopa de números

Encierre en un círculo rojo los números 5 y marque con una cruz verde los números 2:

5	○
2	X

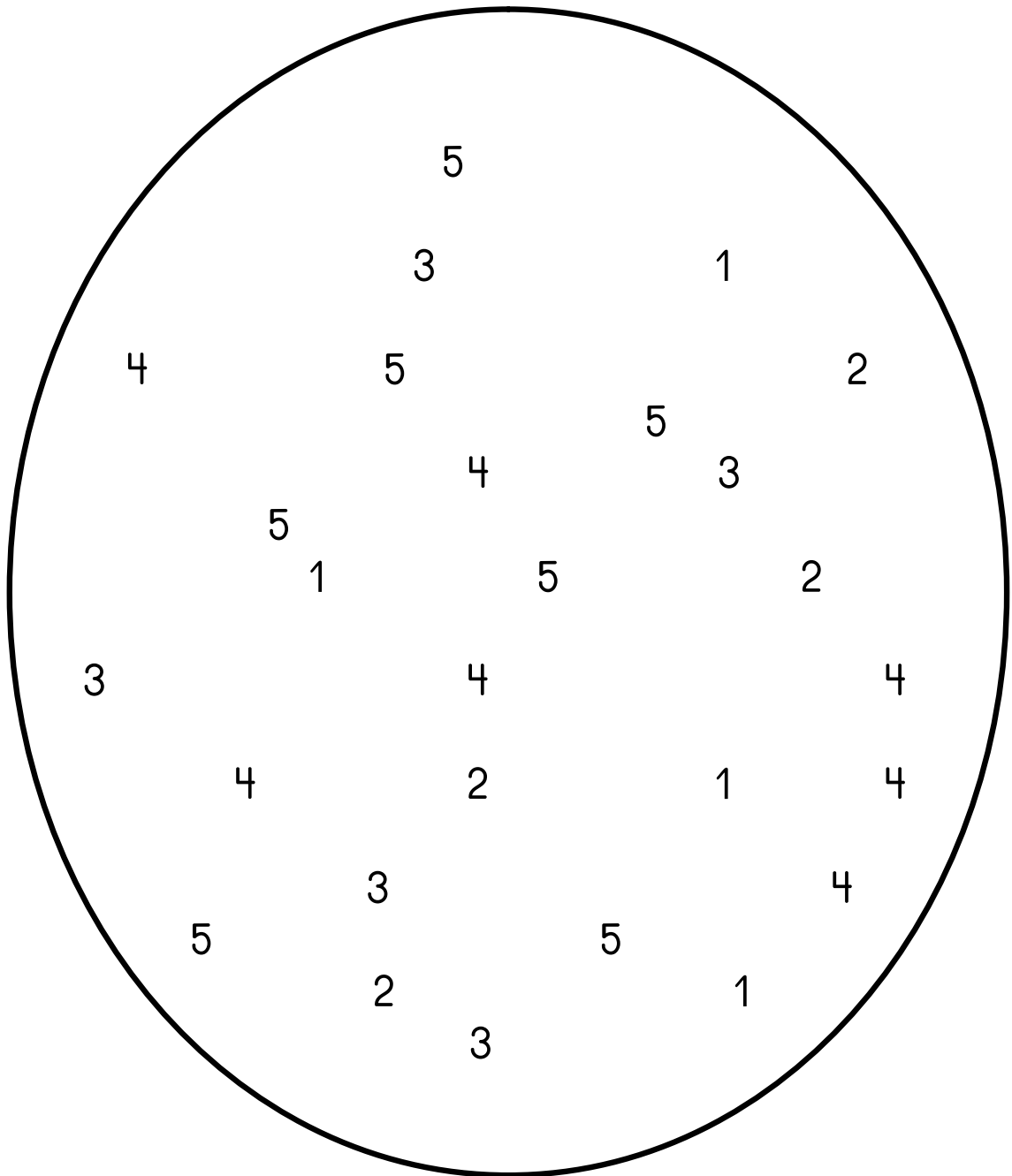

Escribe el número que corresponde a la cantidad de frutas que hay en cada conjunto:

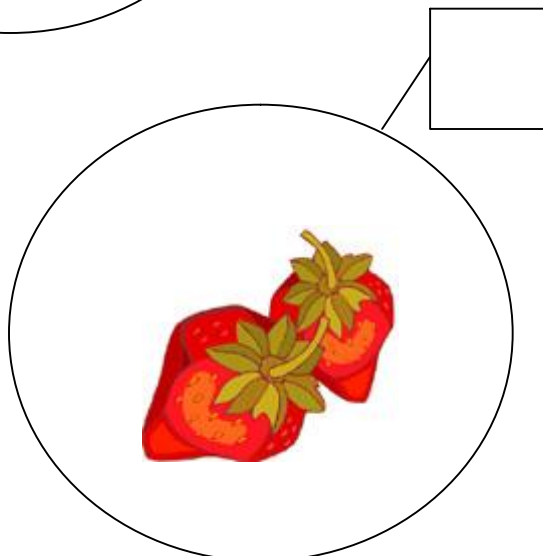
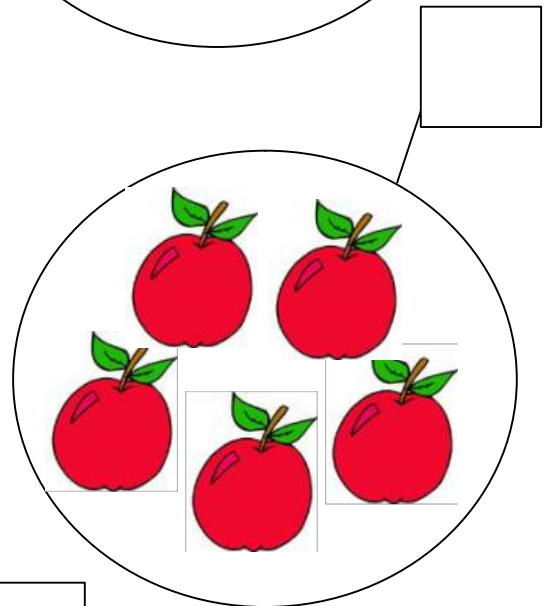
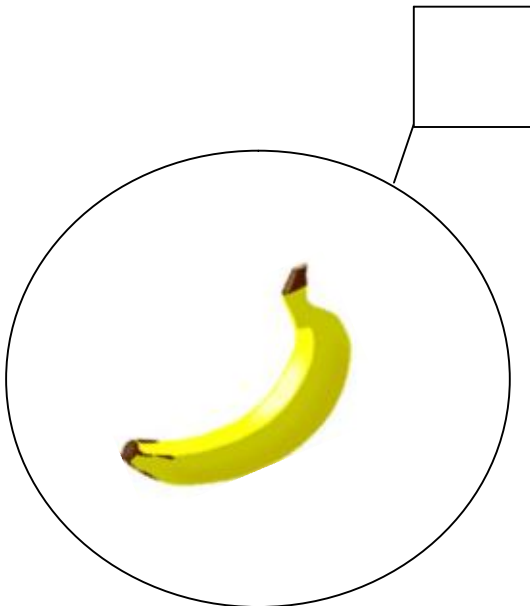
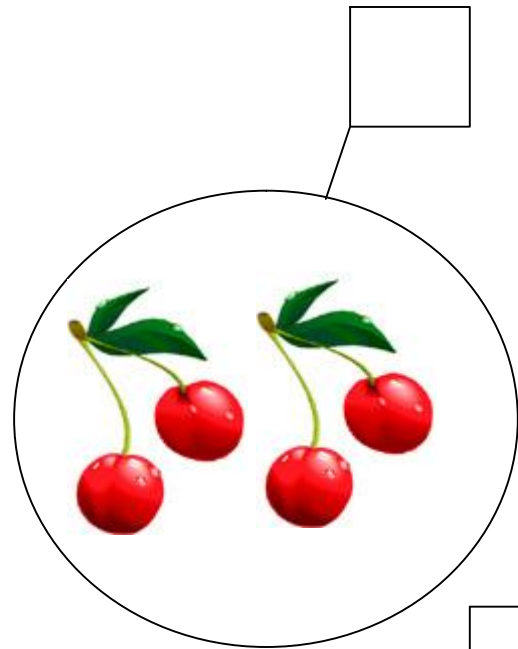
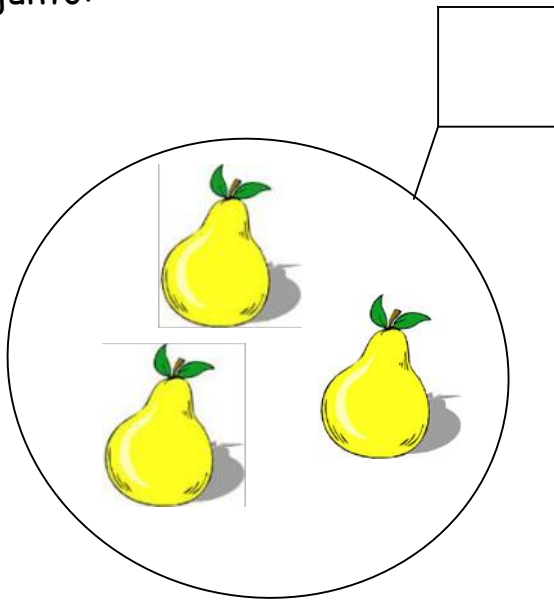

Une con una línea el número con su correspondiente cantidad de insectos.

5

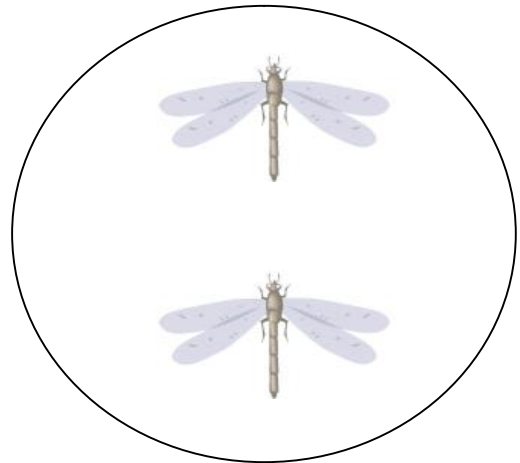

4

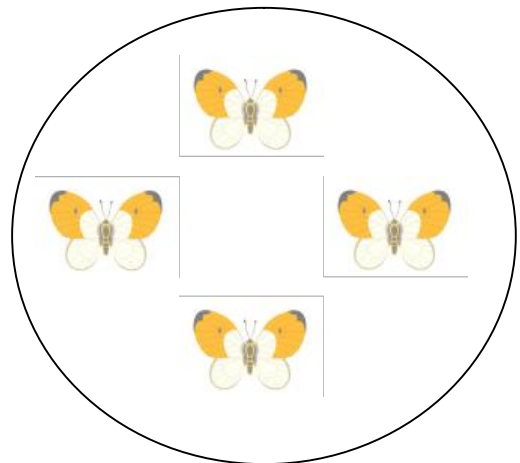

2

3

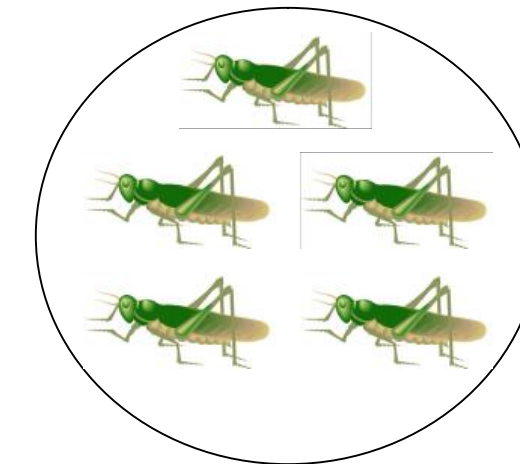

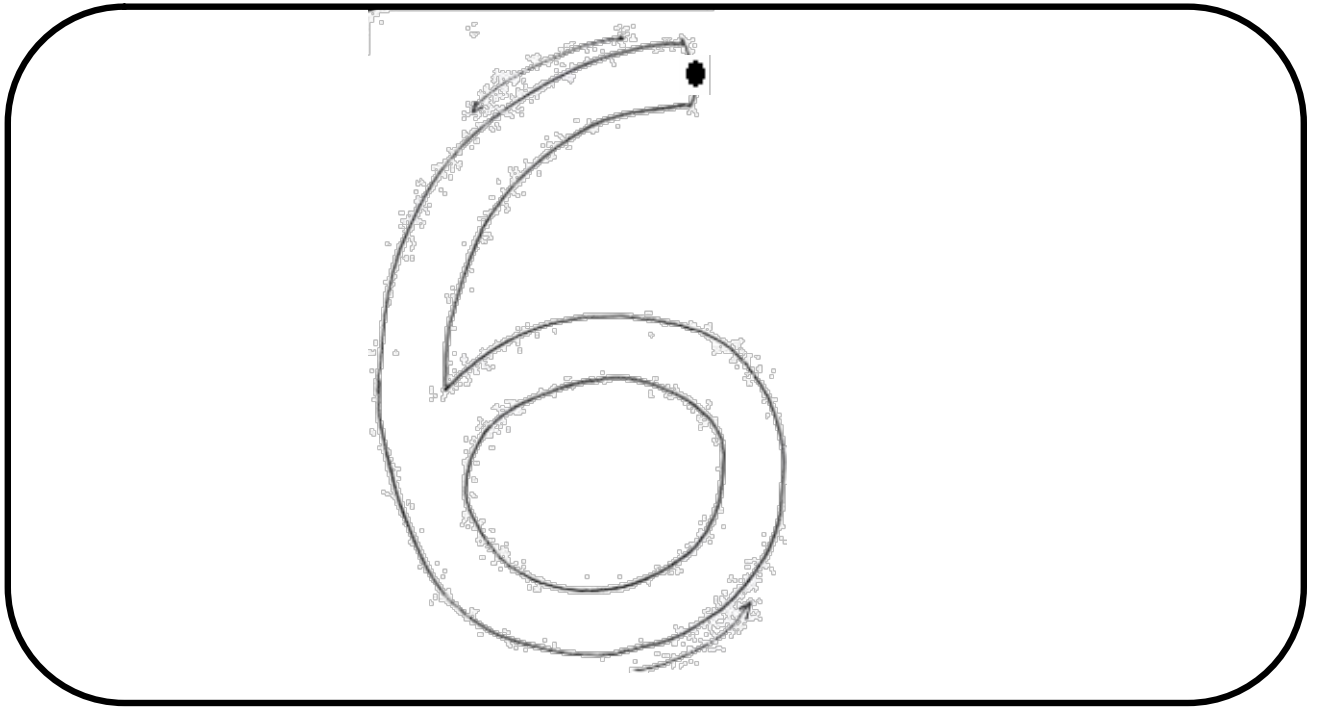

seis

Dibuje 6 (seis) objetos:

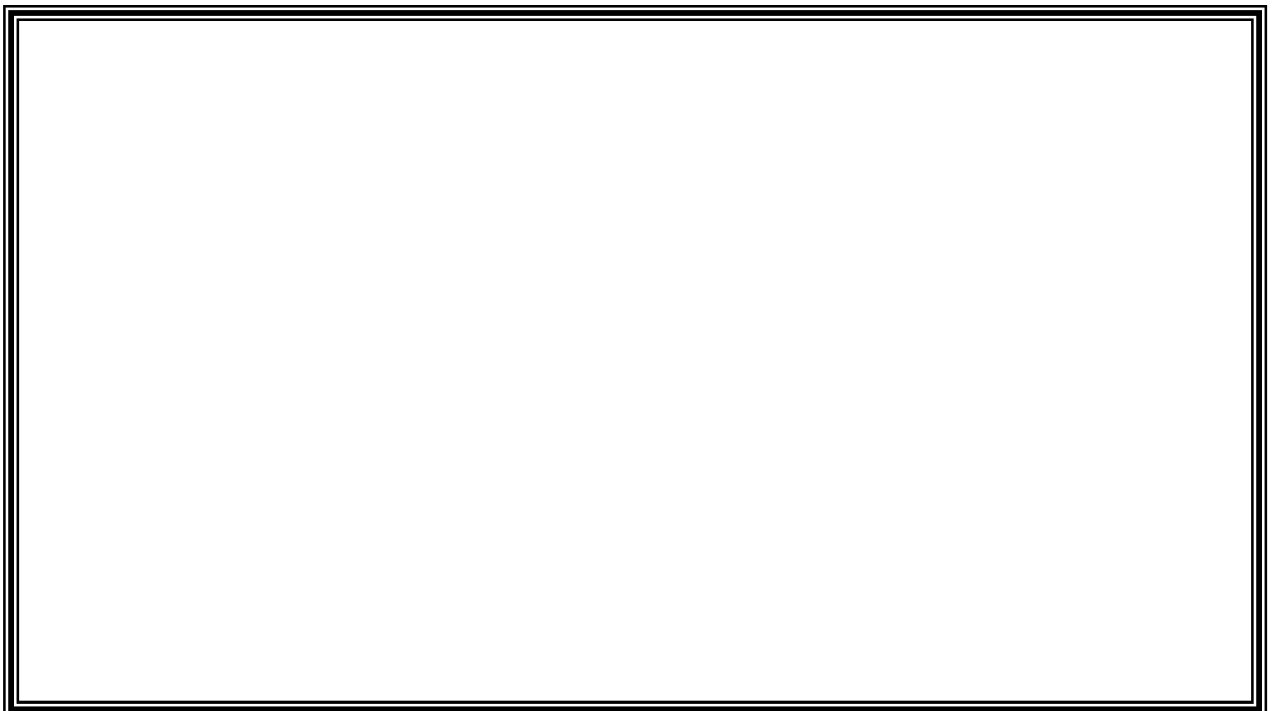

Repase con el dedo índice 3 veces el 6:

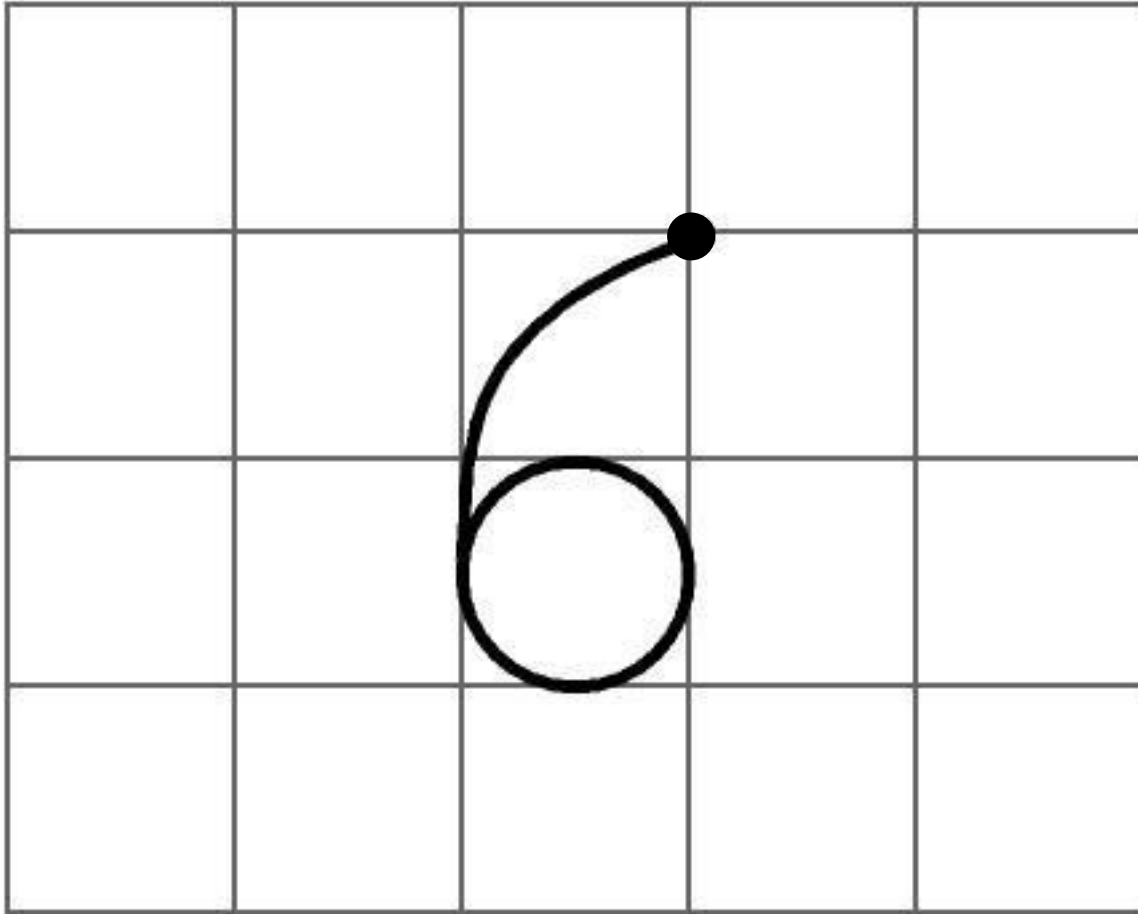

Ahora escríbalo.

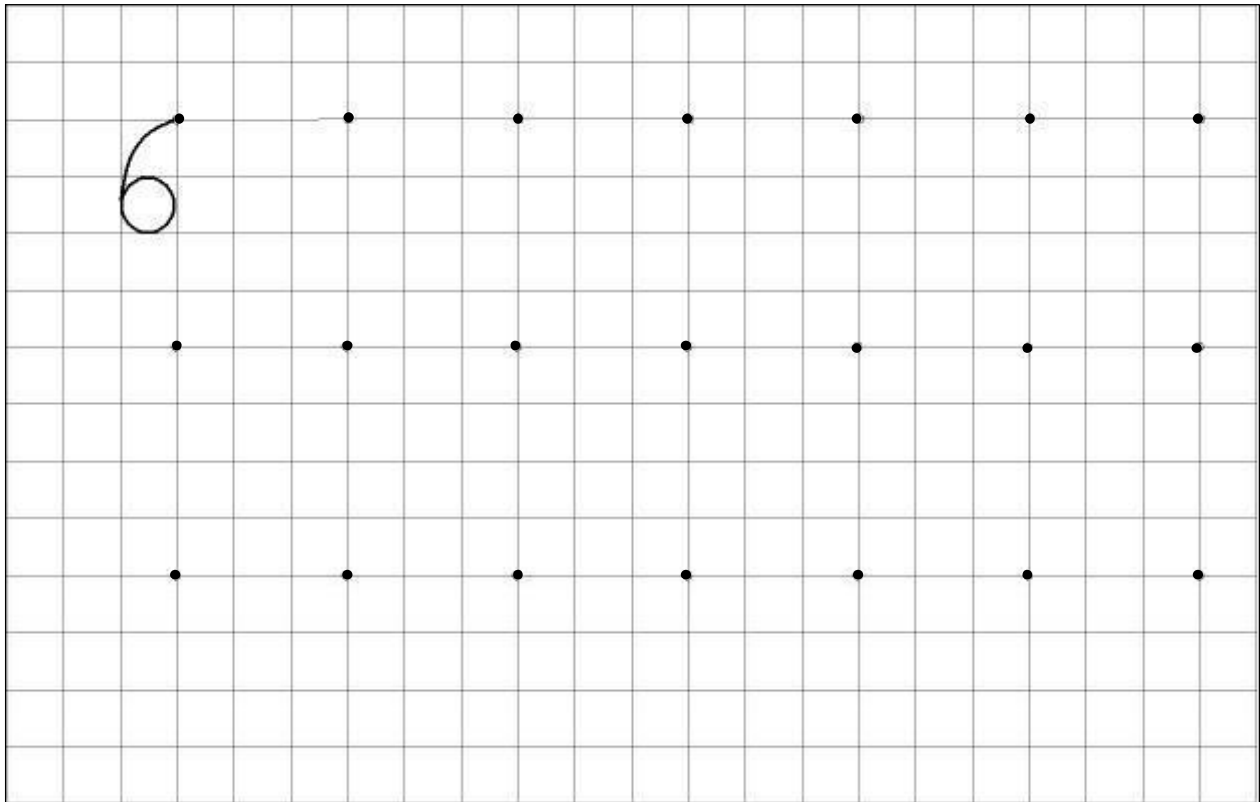

Sopa de números

Encierra en un ○ los números 6 y marca con una X los números 9:

6	○
9	X

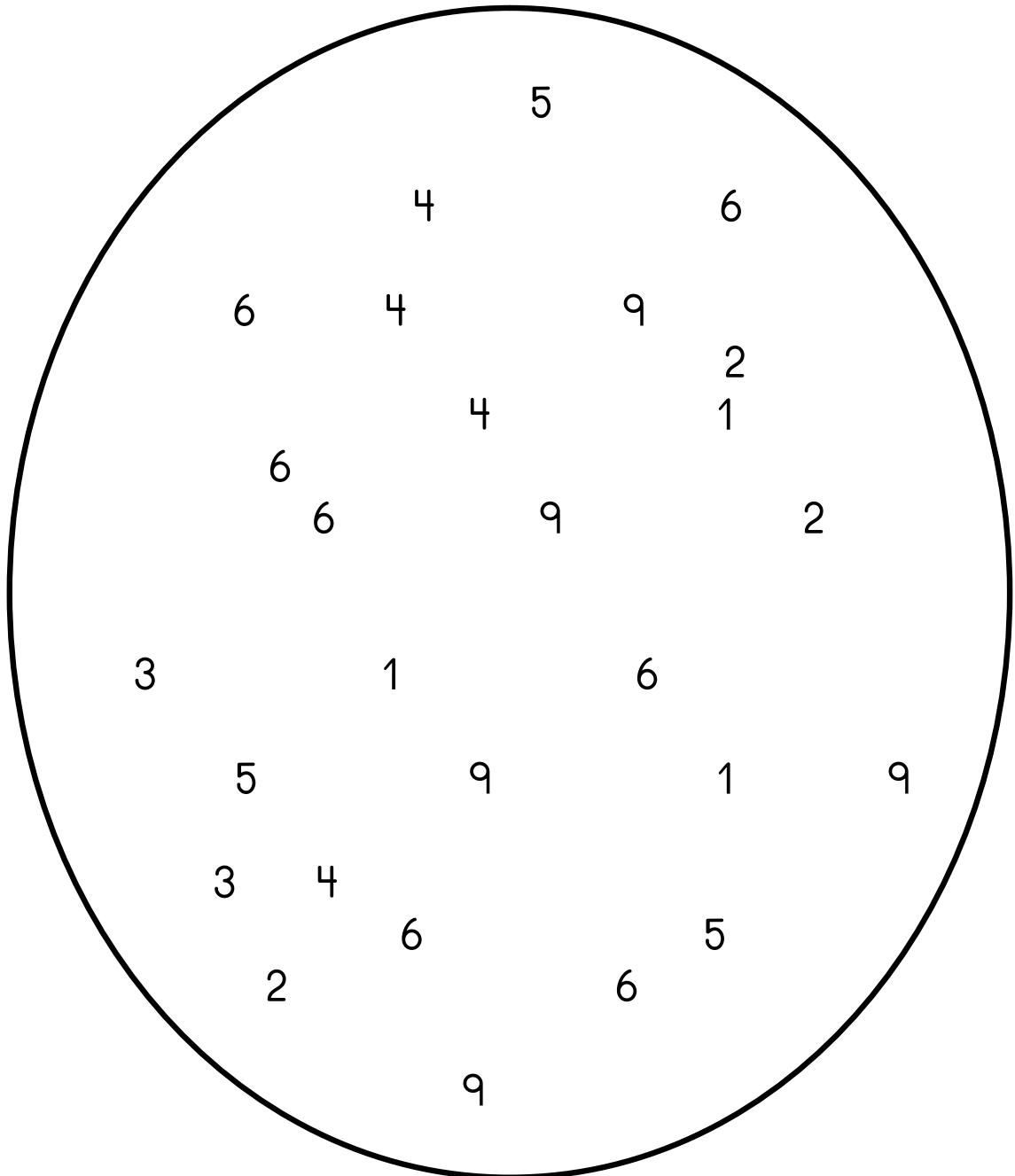

Cuenta los peces y escribe el número.

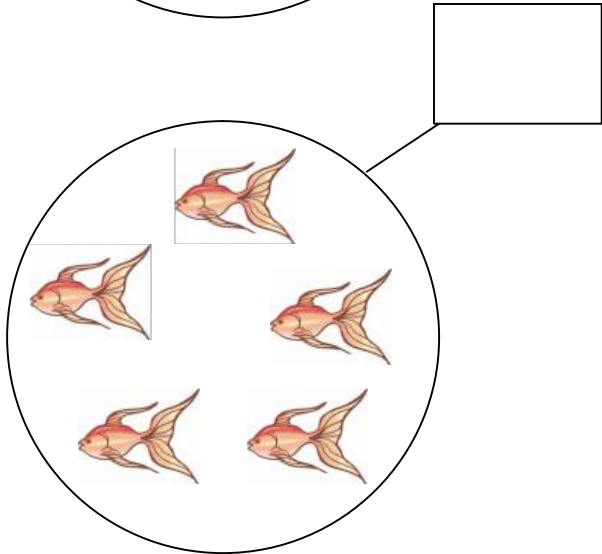
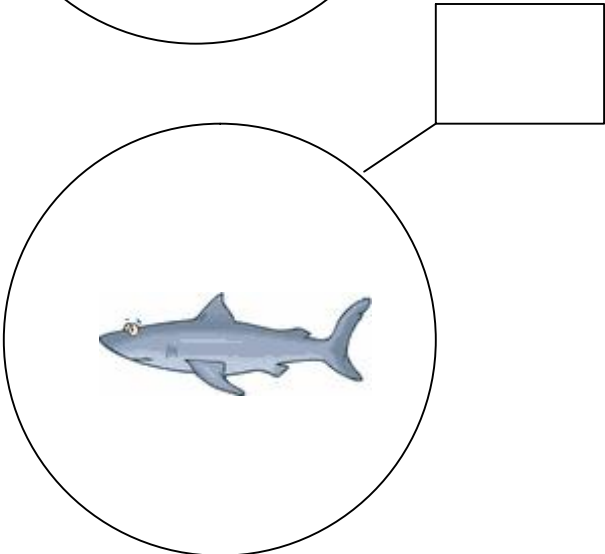
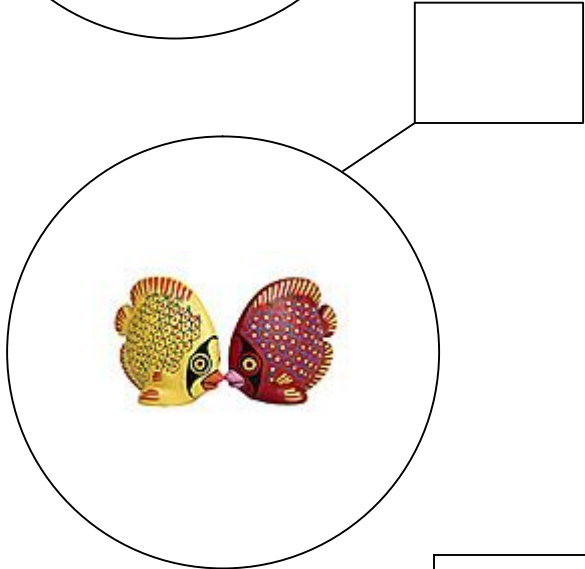
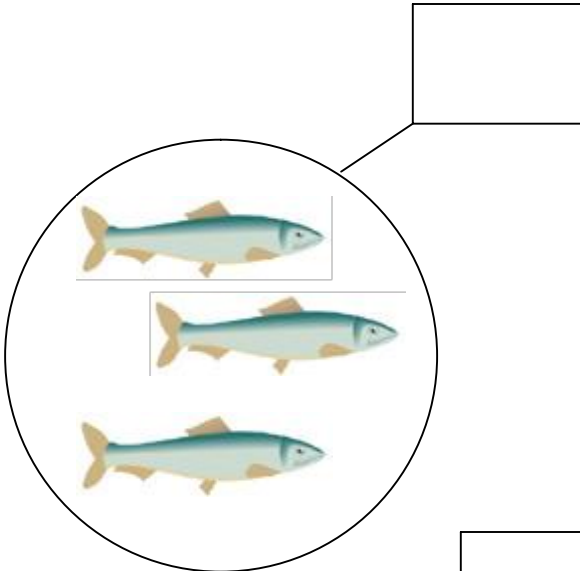
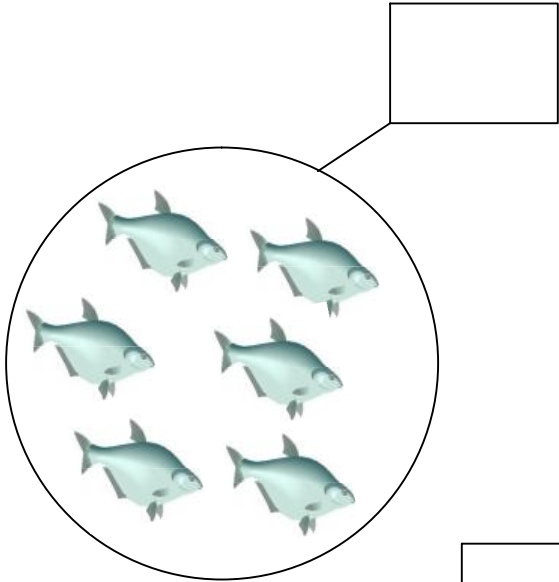
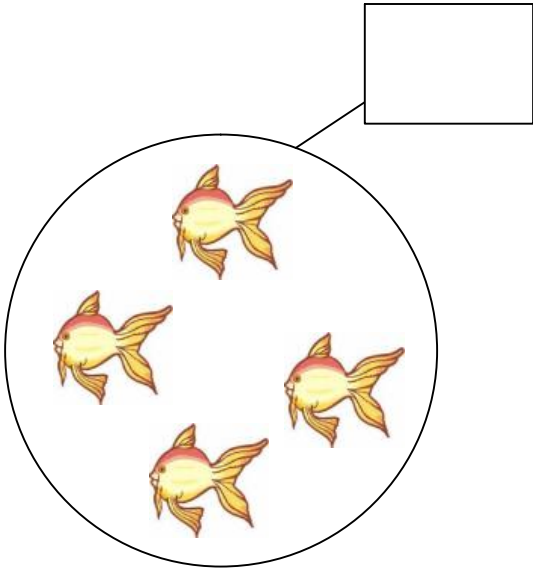

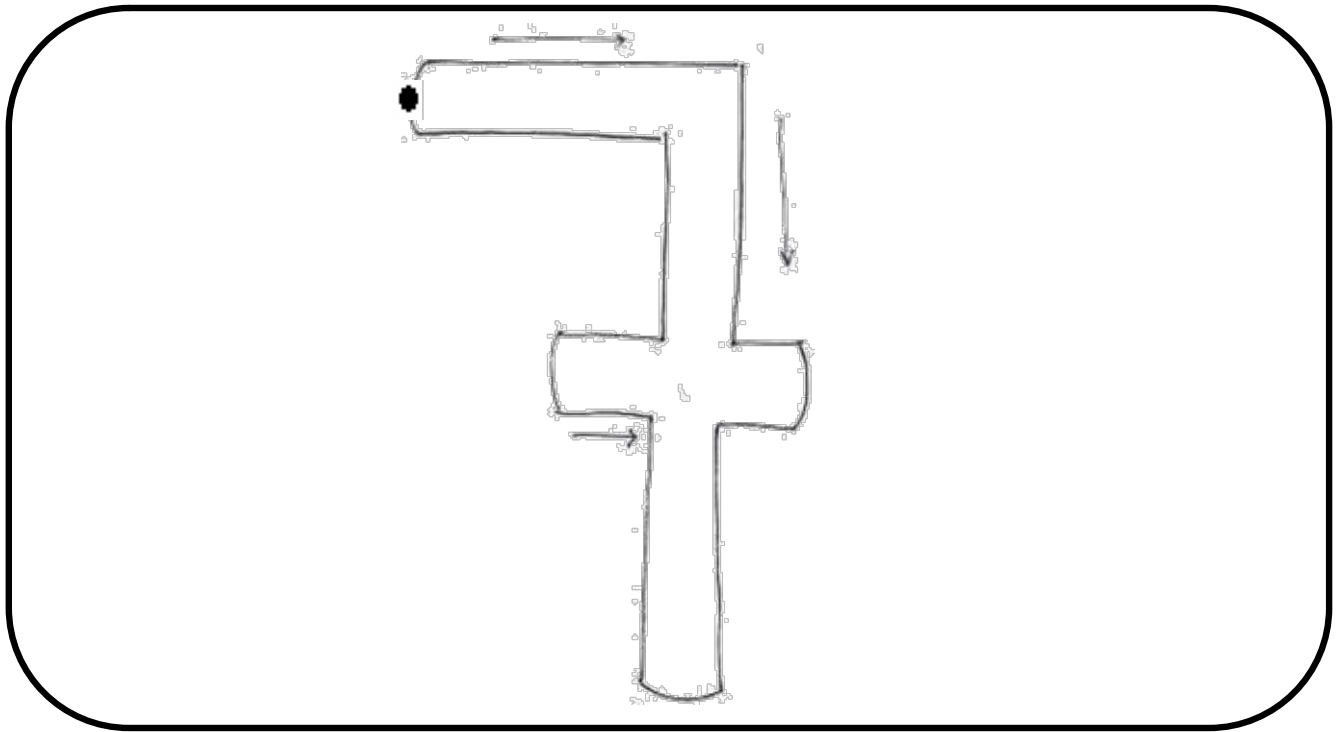

siete

Dibuje 7 (siete) objetos:



Repase con el dedo índice 3 veces el número 7:

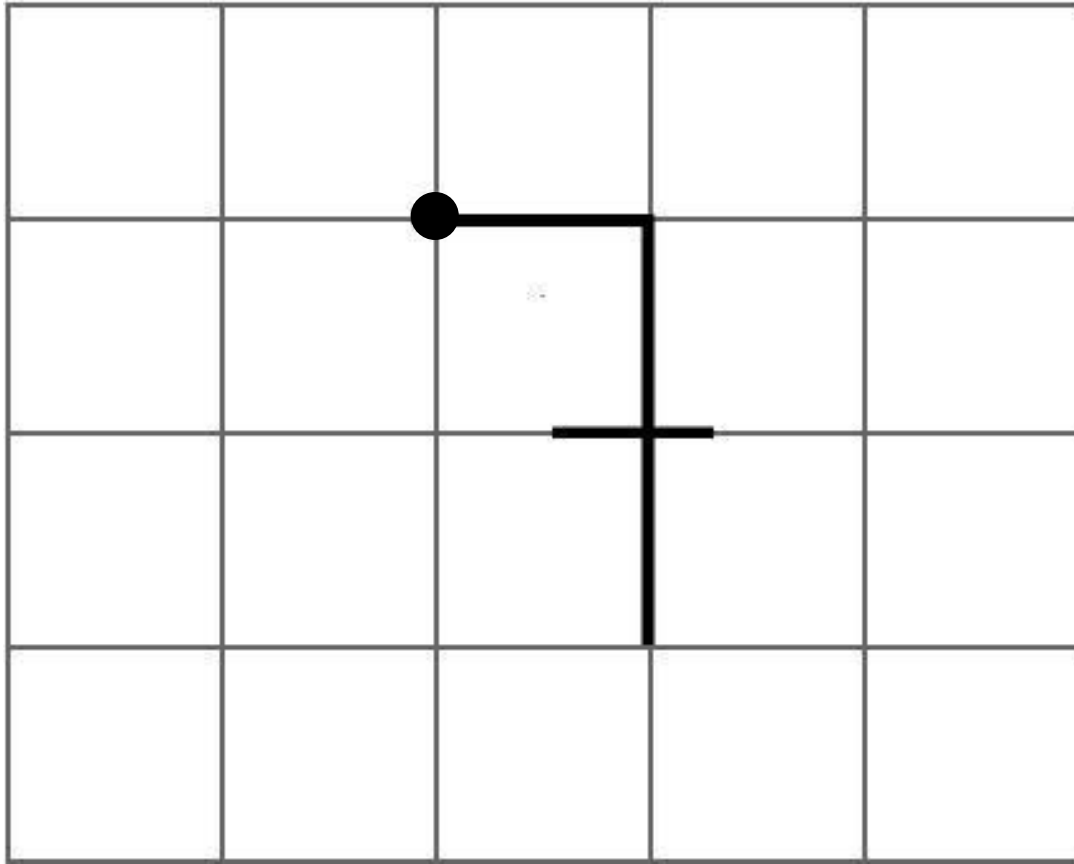

Ahora escríbalo.

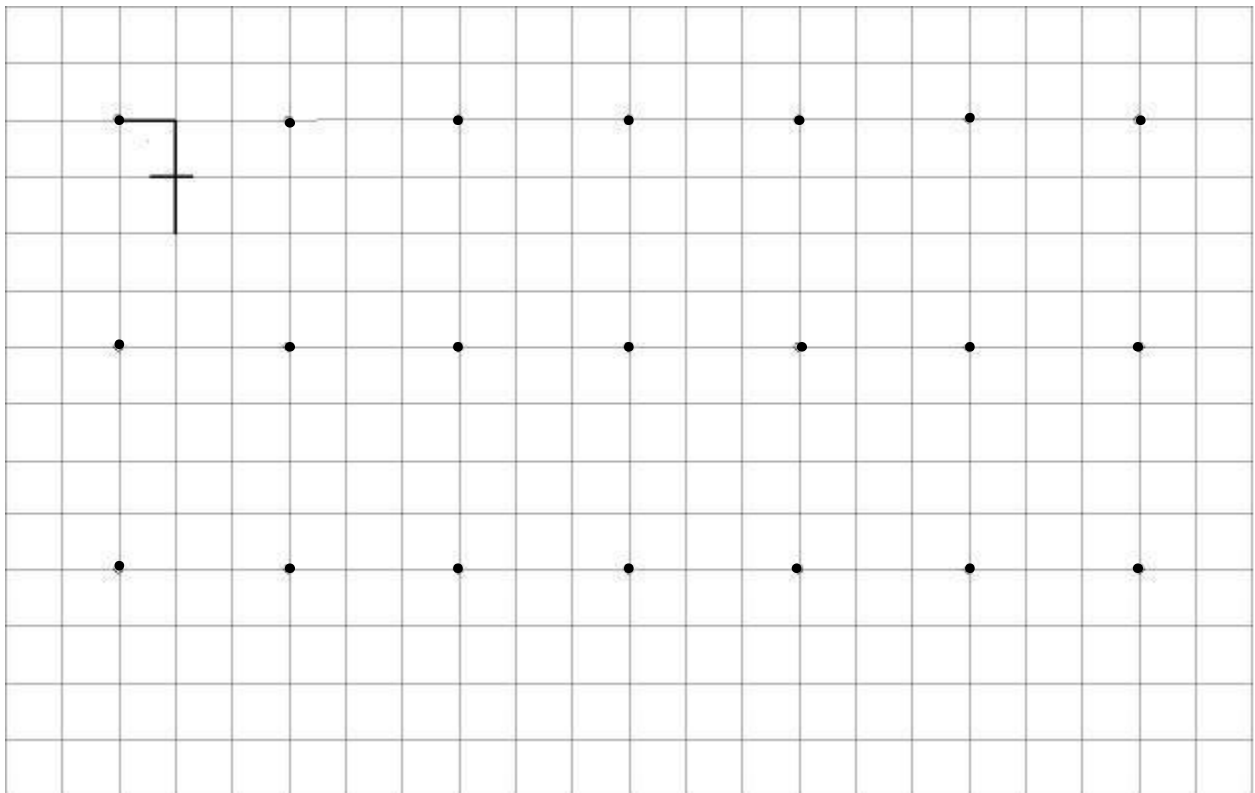



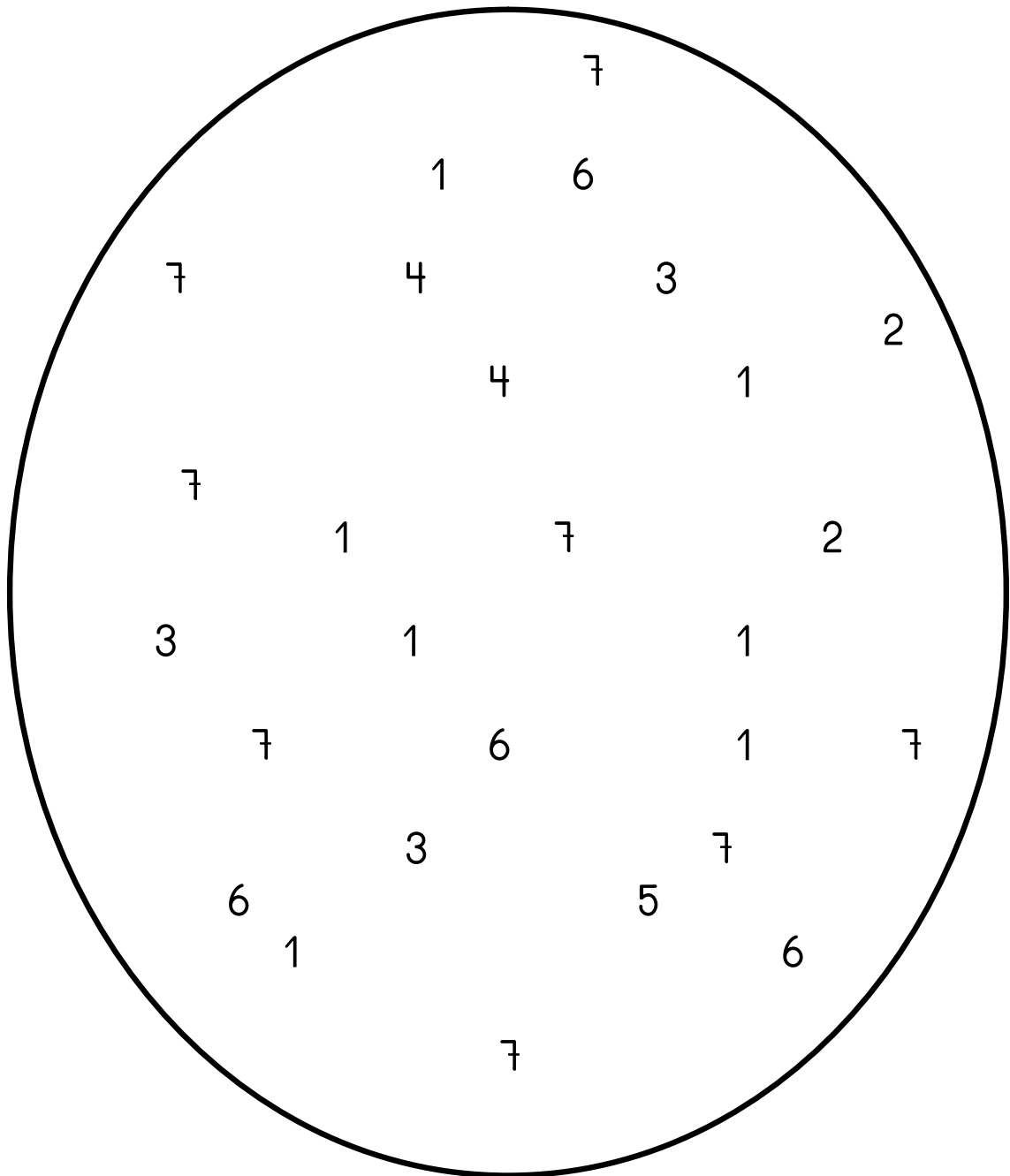

Sopa de números

Marque con una X los números 7 y encierre en un ○ los números 1:

7	X
1	○

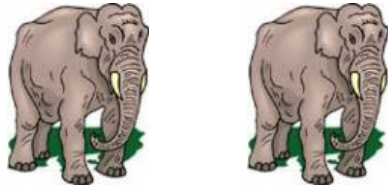

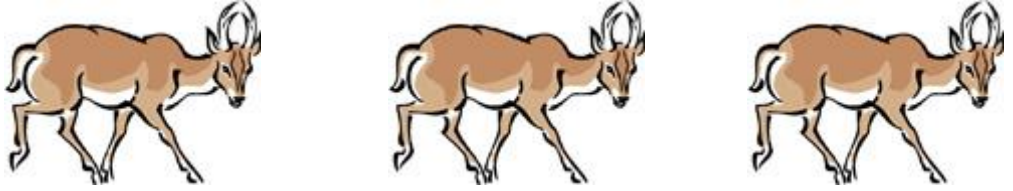
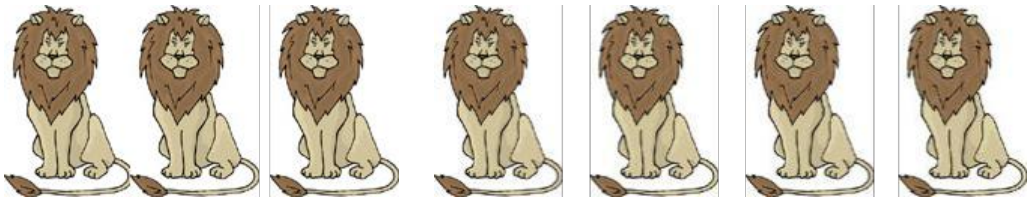
Escribe la cantidad de animales que corresponde en cada riel

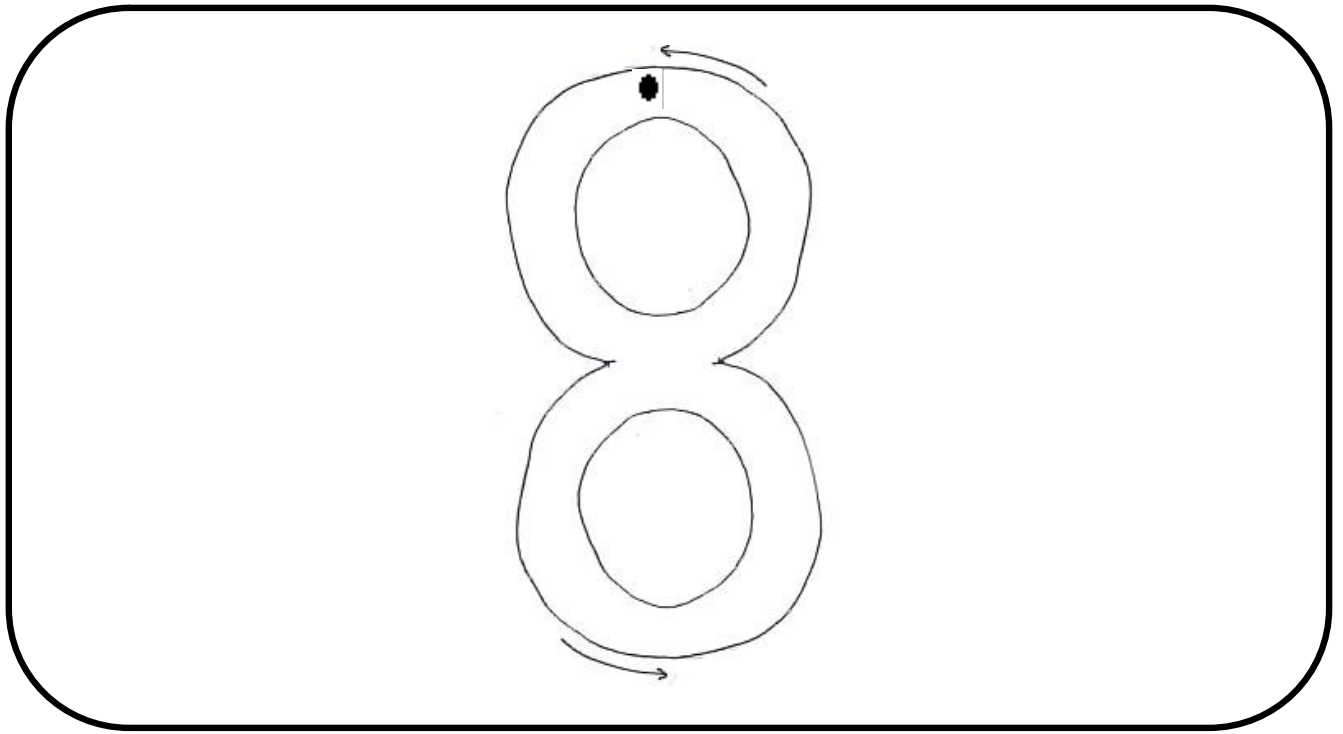

ocho

Dibuje 8 (ocho) objetos:



Repase con el dedo índice 3 veces el número 8:

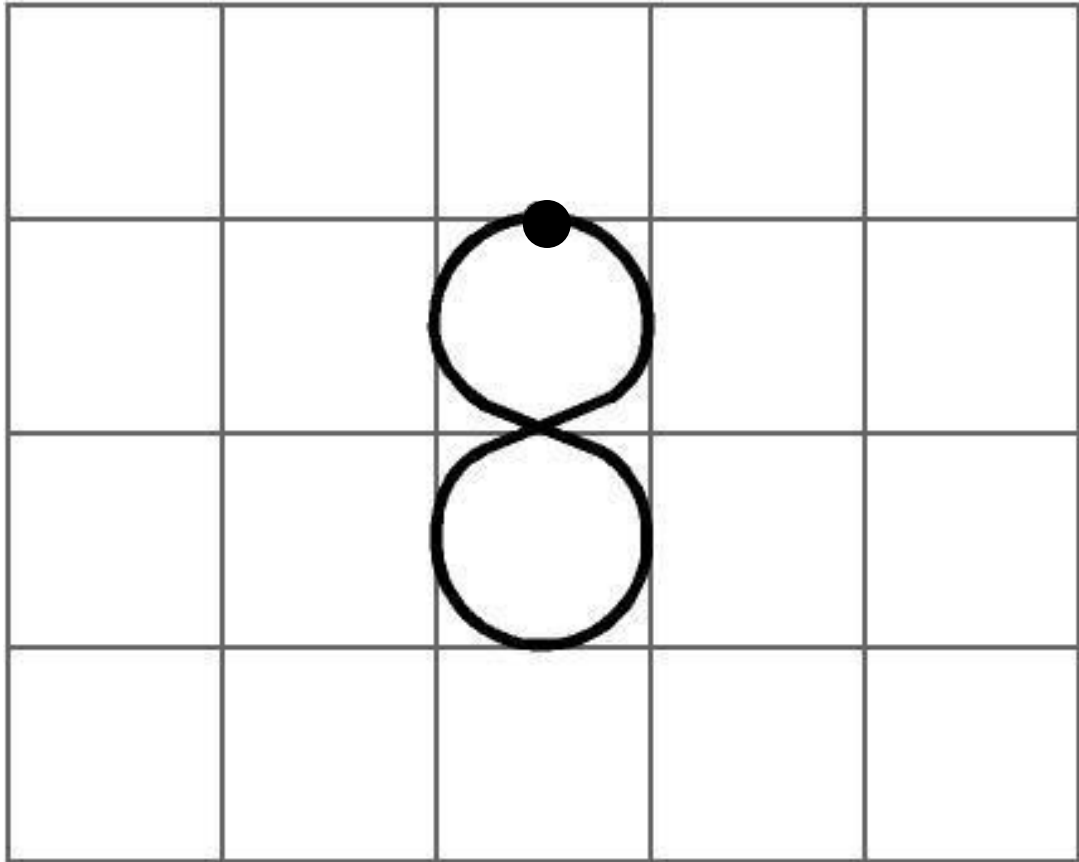

Ahora escríbalo.

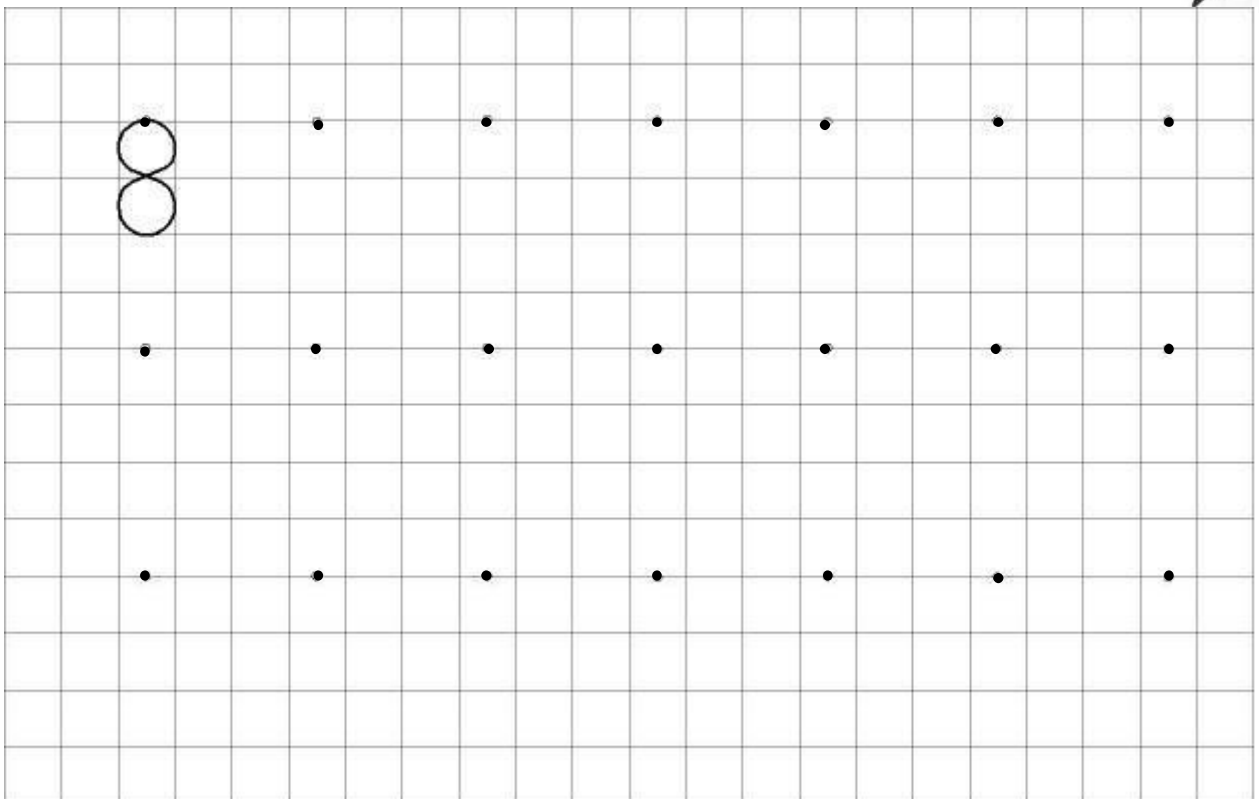

Sopa de números

Encierre en un círculo los números 8

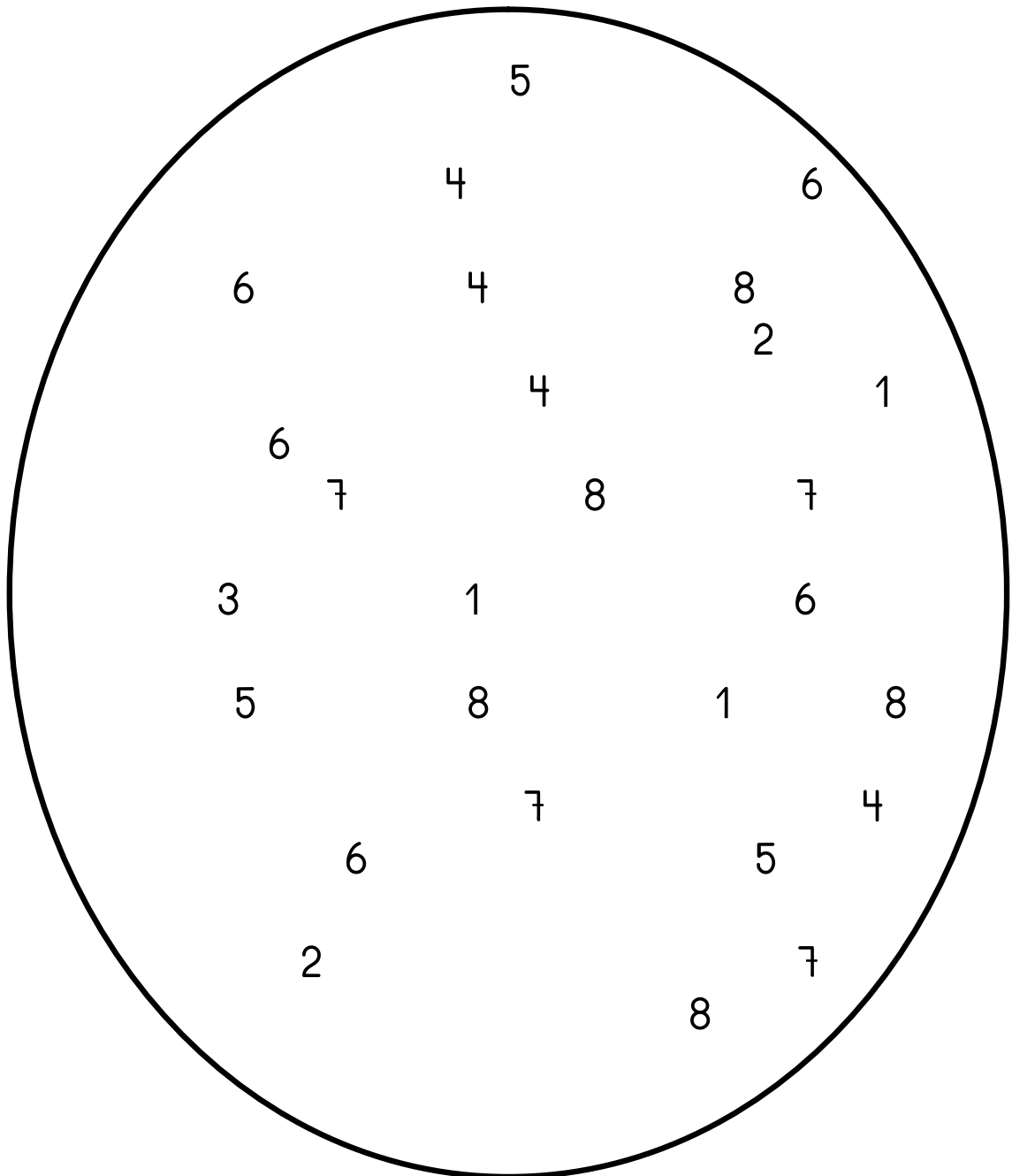

Una el número con el grupo que contenga la misma cantidad de aves

6

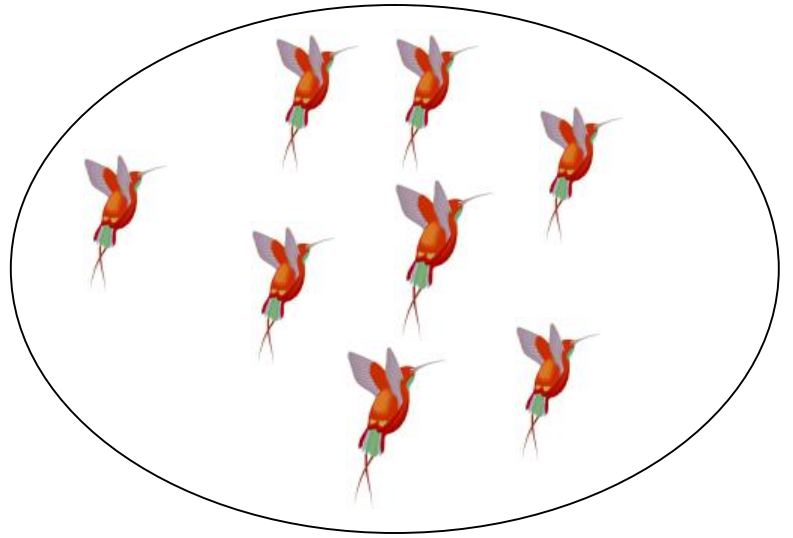

8

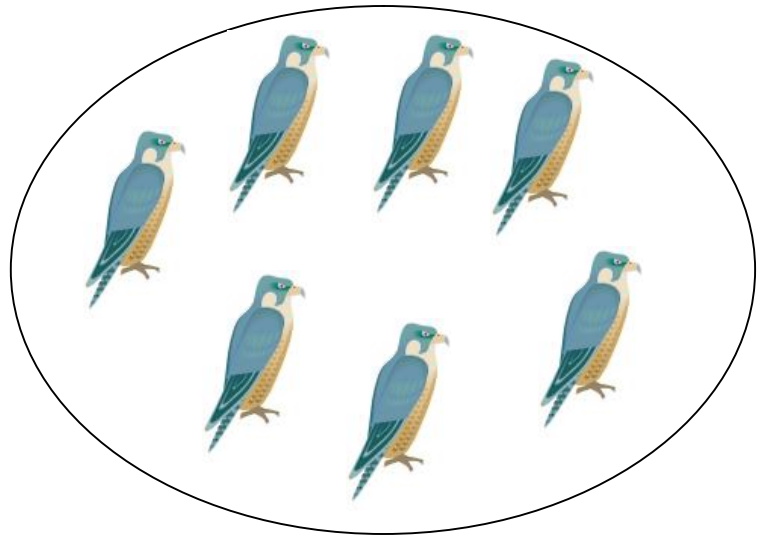

7

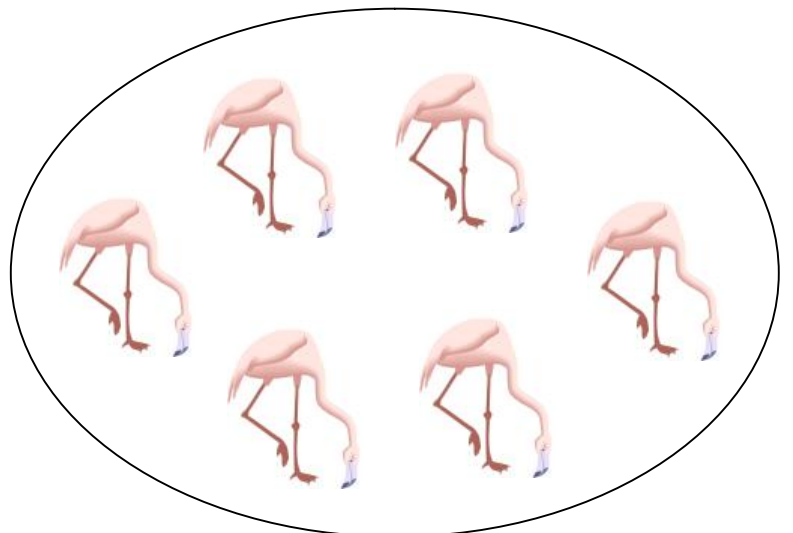

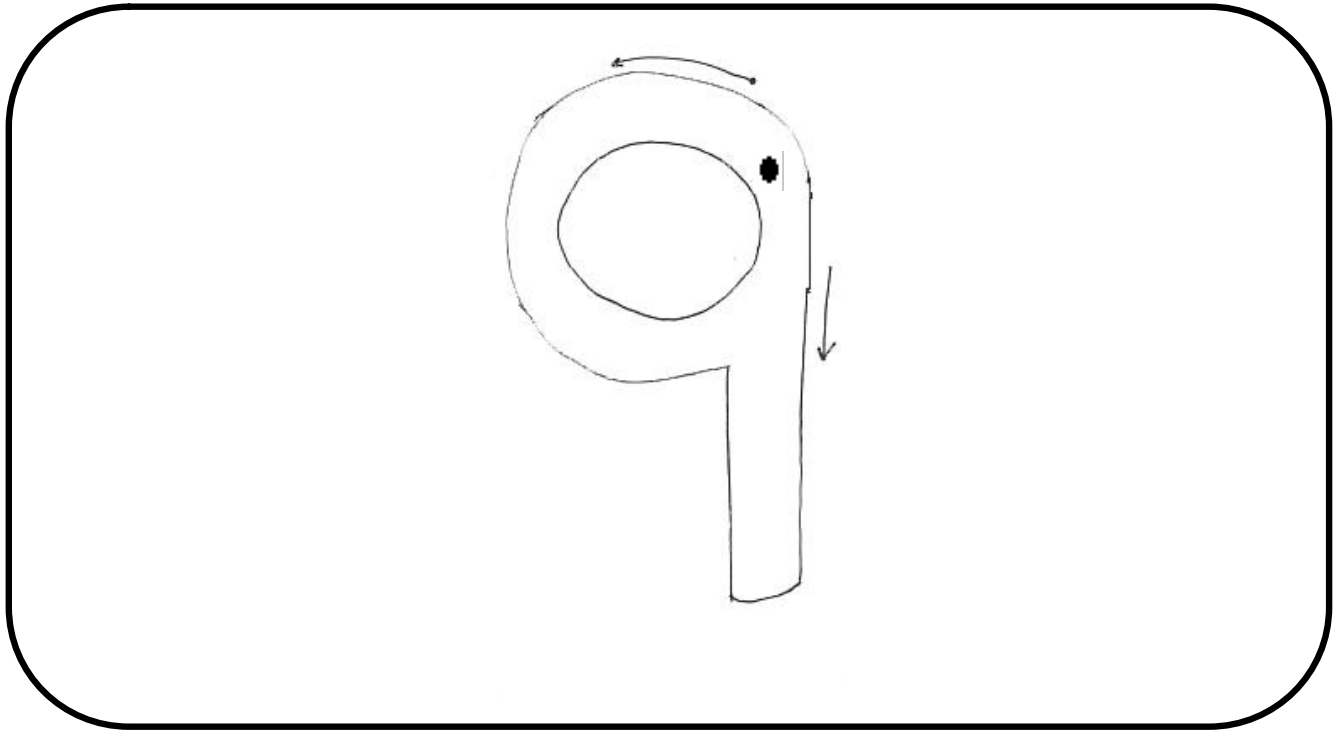

nueve

Dibuje 9 (nueve) objetos:



Repase con el dedo índice 3 veces el número 9:

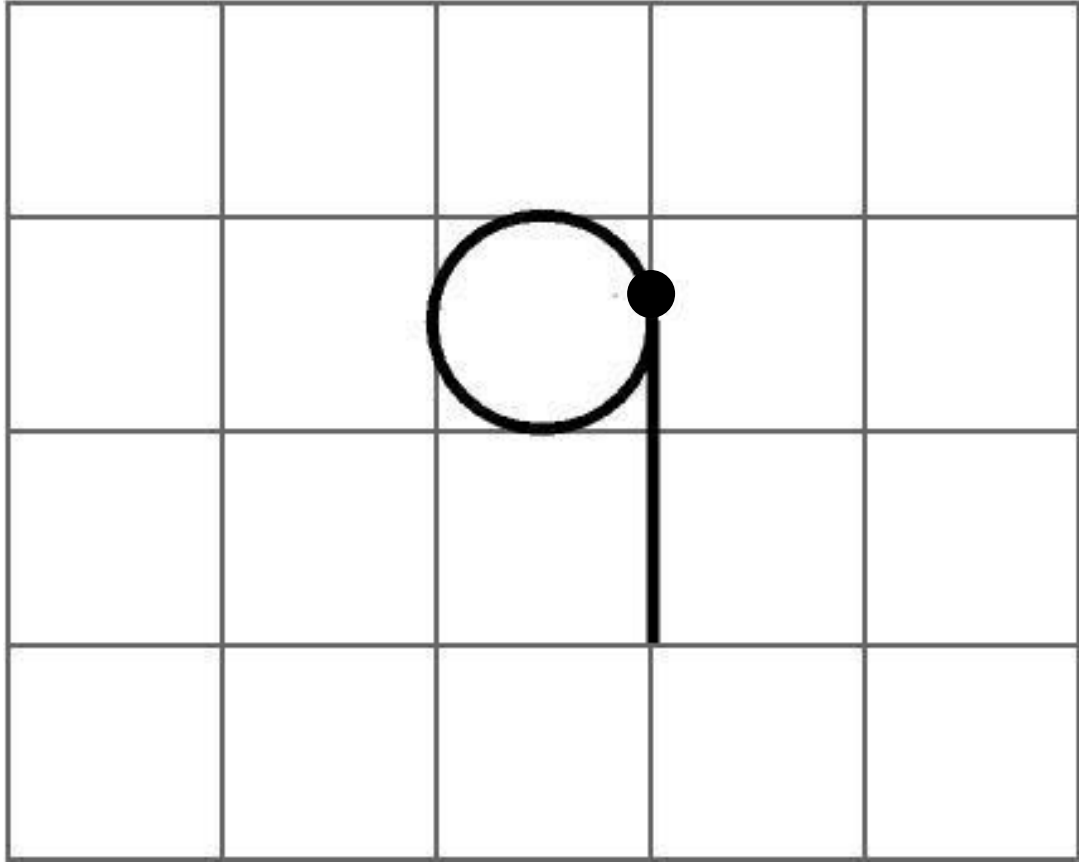

Ahora escríbalo.

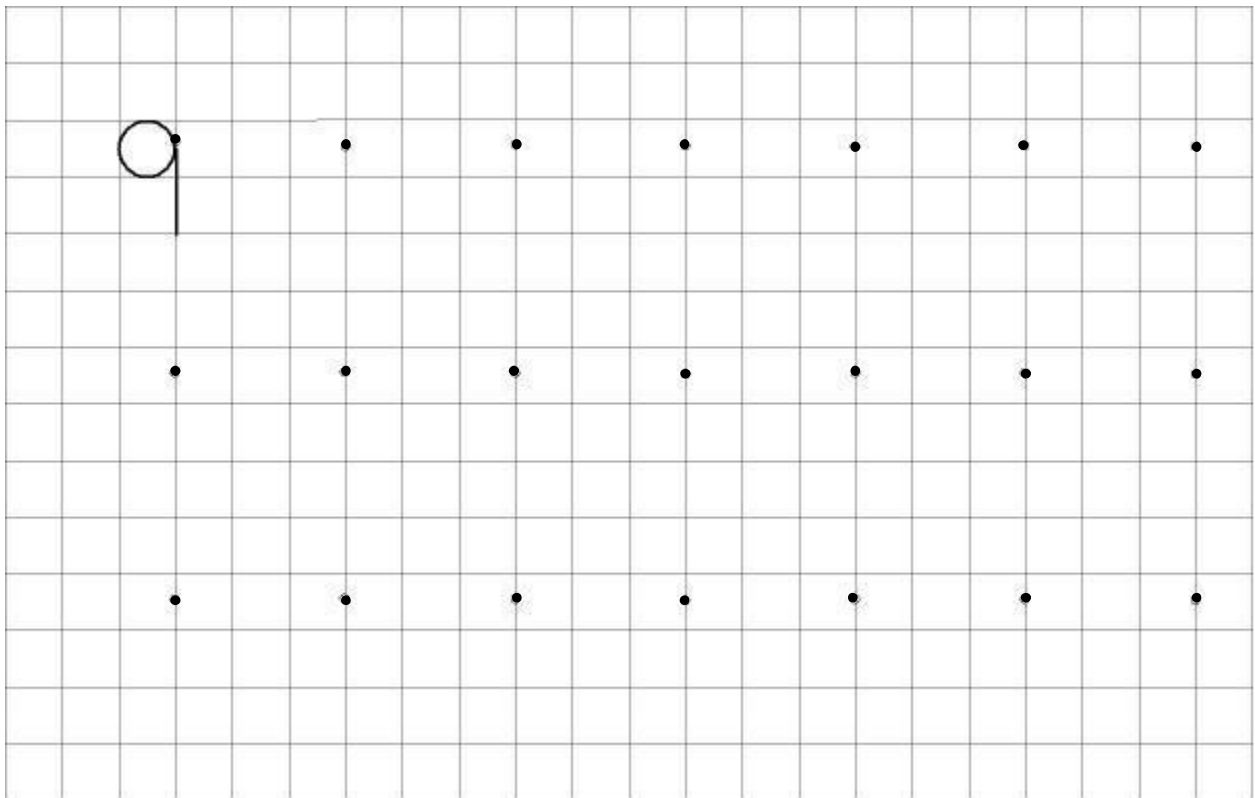



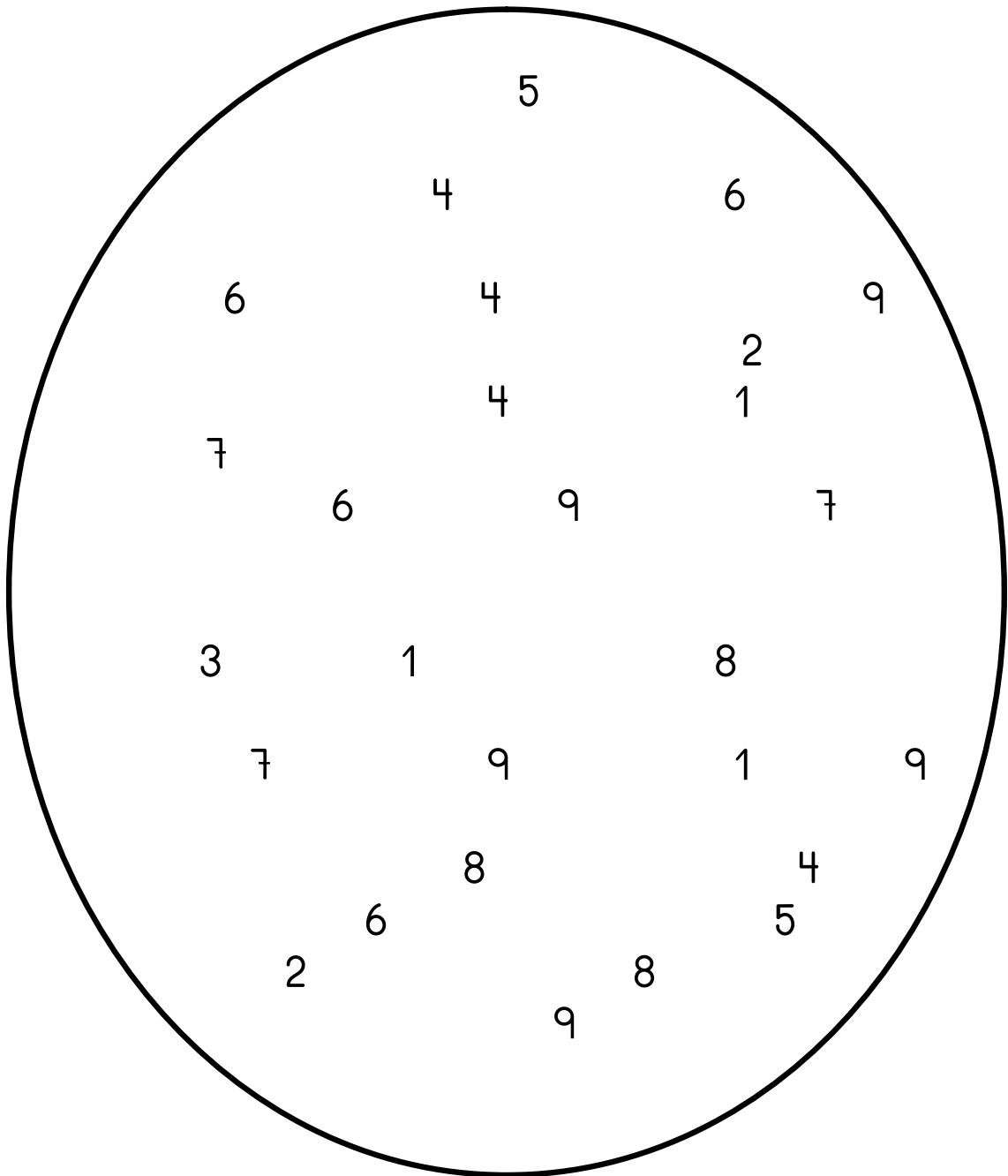

Sopa de números

Encierra en un los números 9:

9	<input type="radio"/>
---	-----------------------

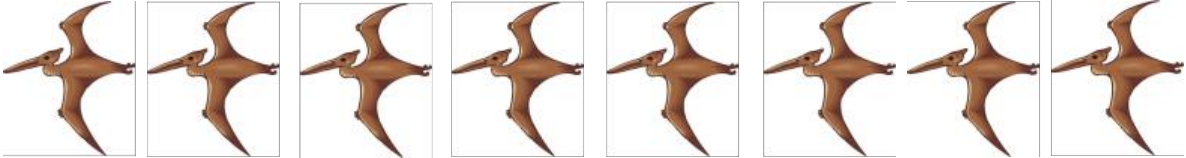
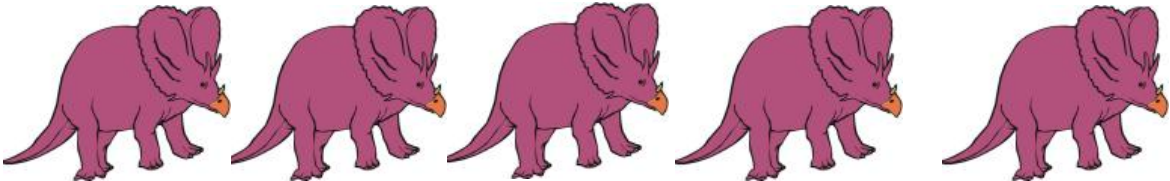
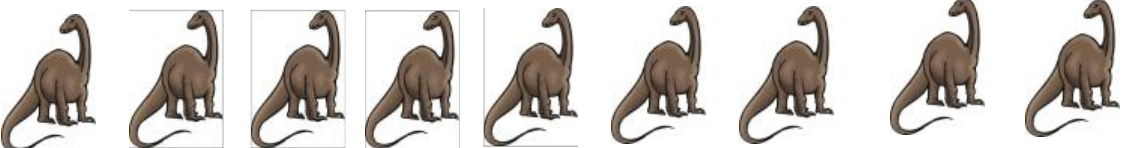
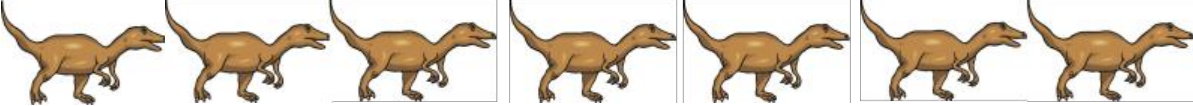

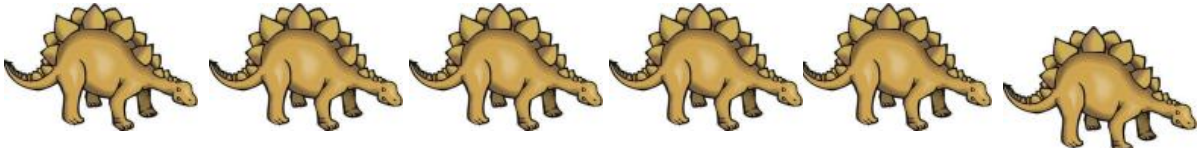
Cuente y escriba el número correspondiente en cada riel

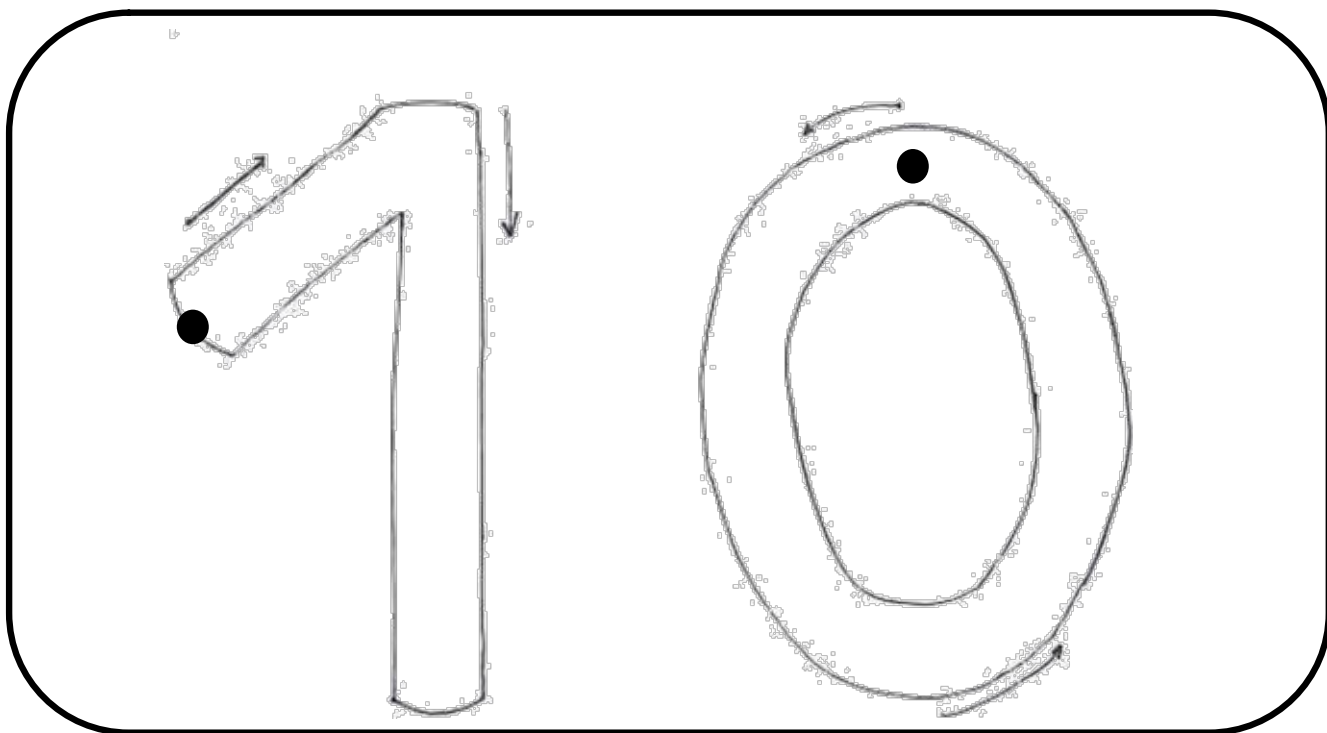

diez

Dibuje 10 (diez) objetos:

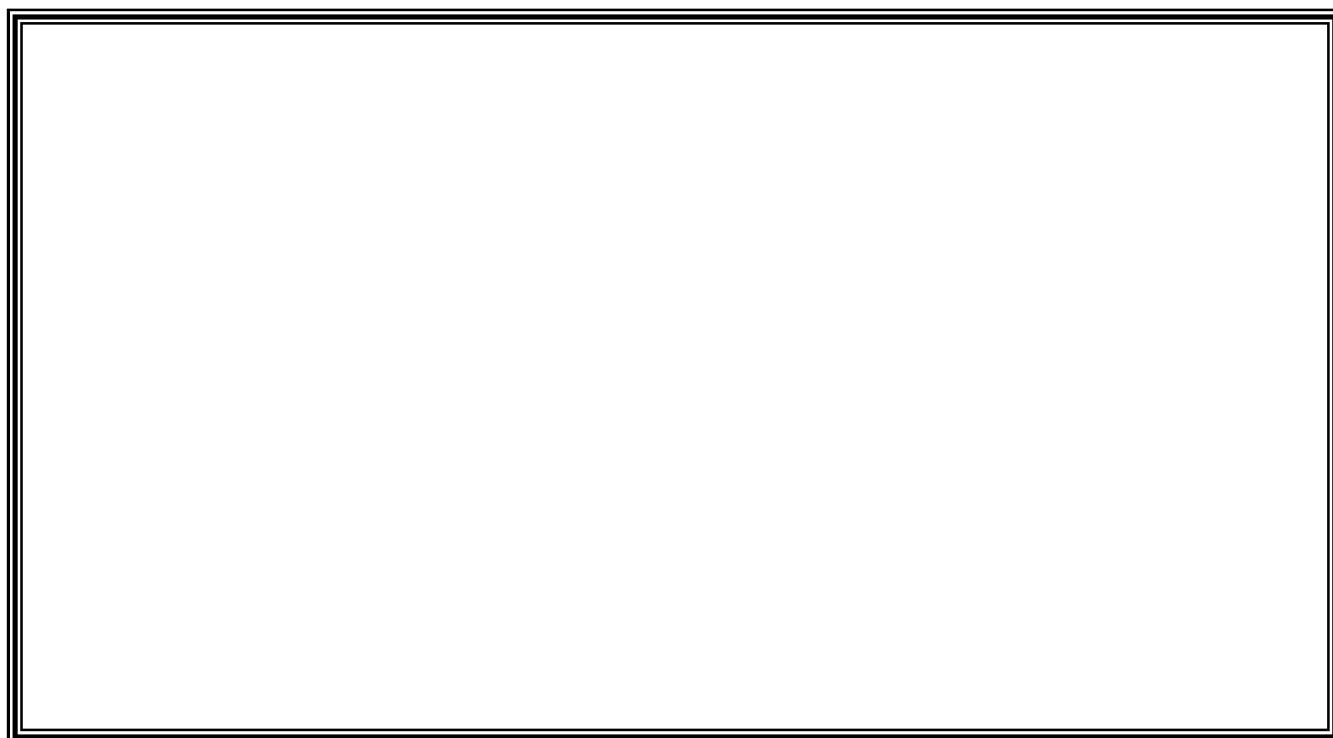

Repase con el dedo índice 3 veces el número 10:

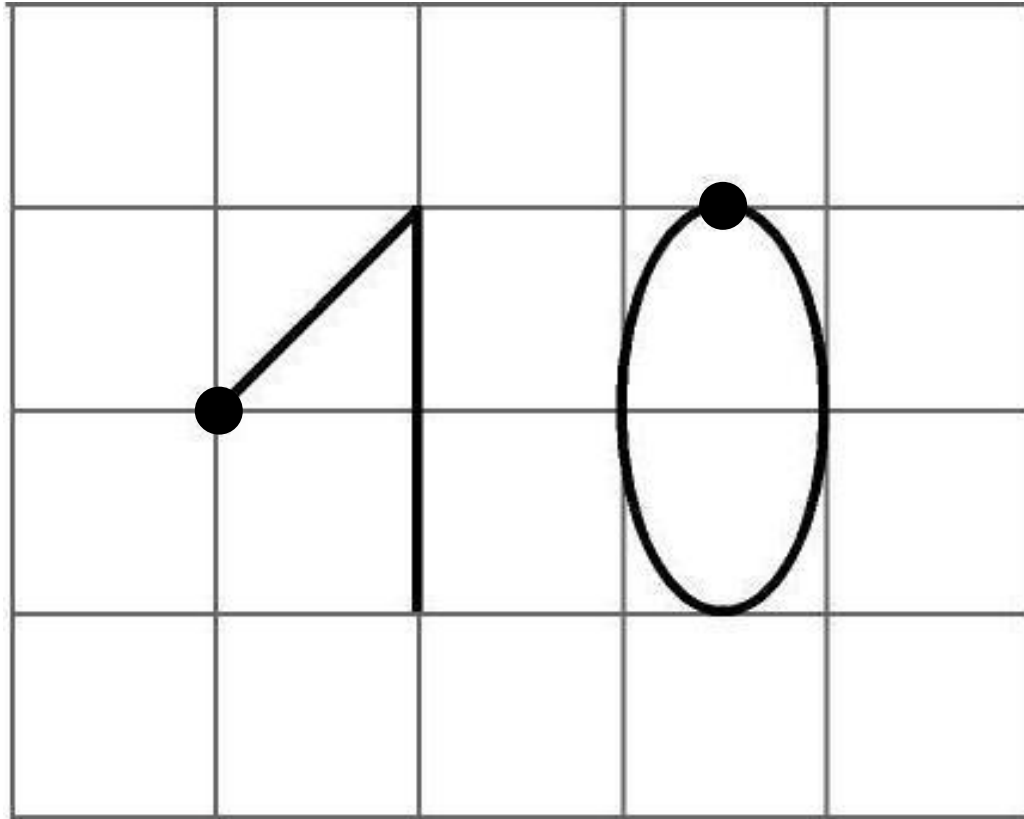

Ahora escríbalo.

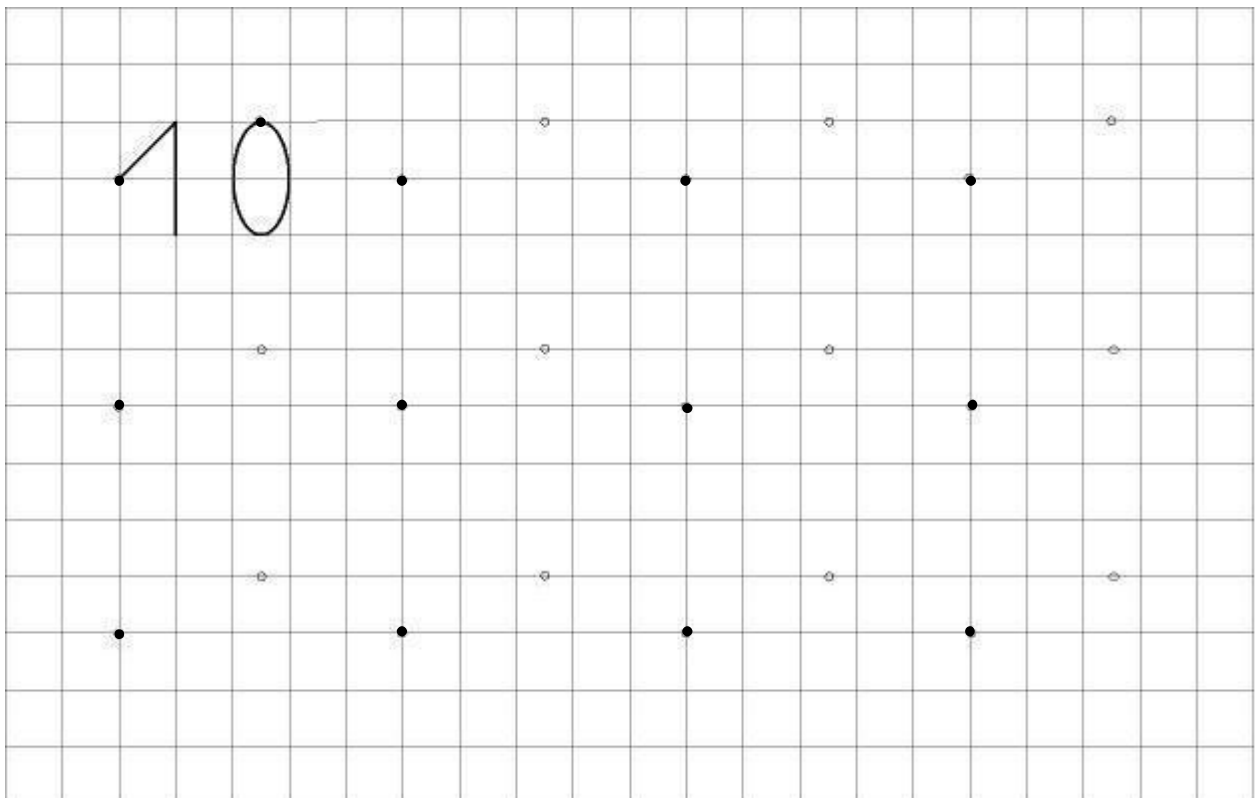

Sopa de números

Encierre en un círculo verde los números 10:

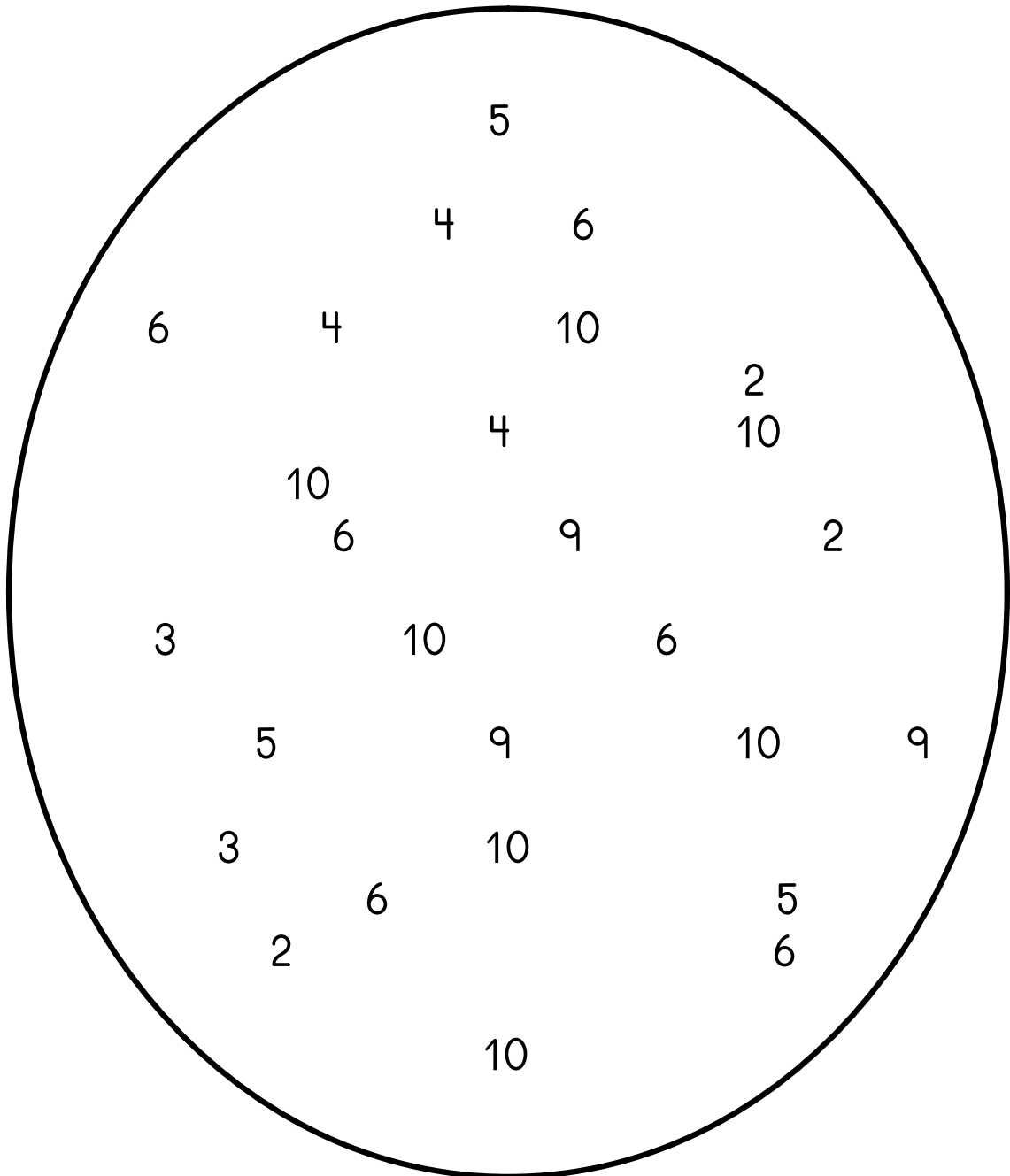

Pinte las monedas de 10 y escriba cuantas pintó

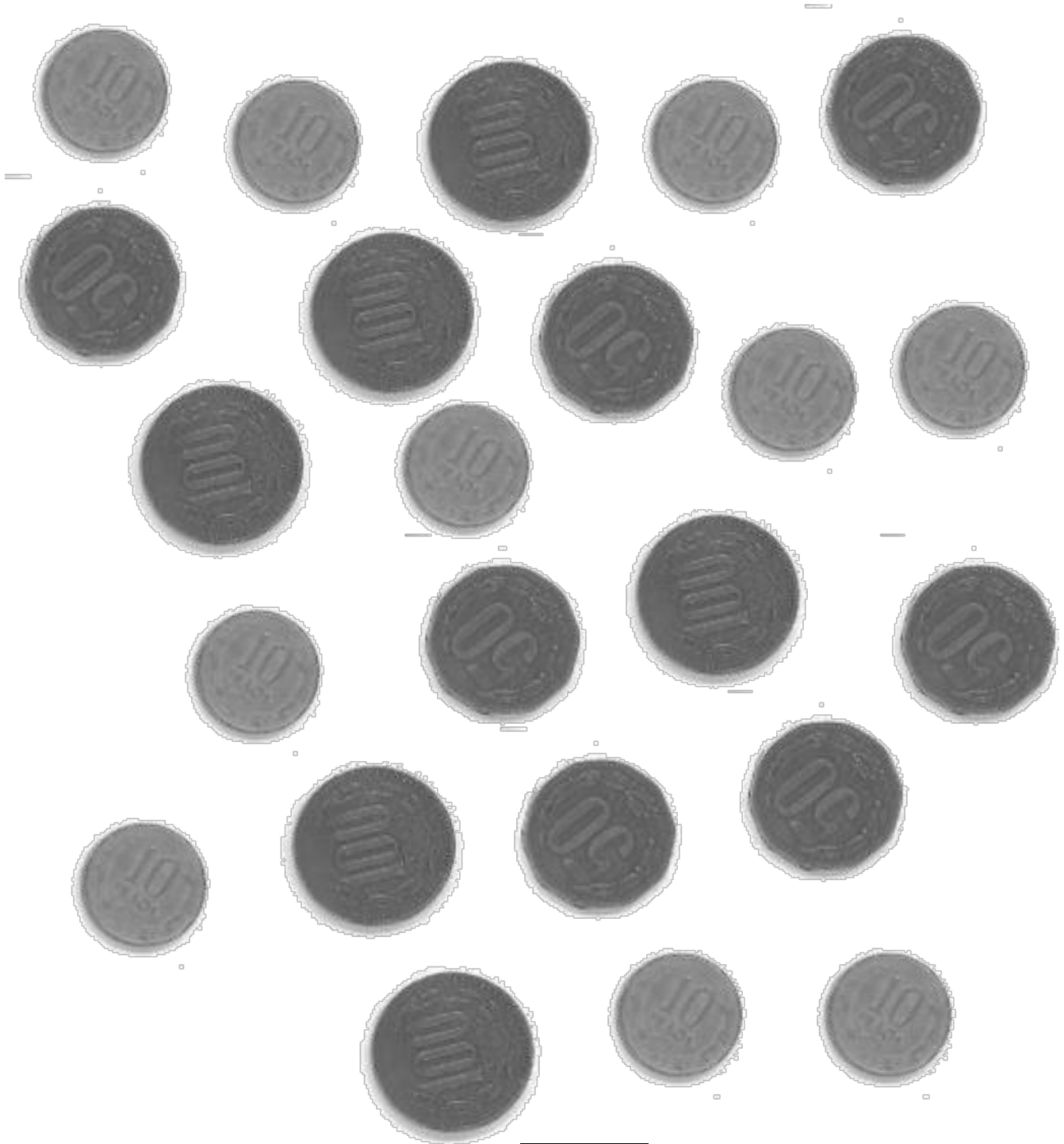

¿Cuántas monedas de \$10 pintó?

Dado el número escribe el que va antes y el que va después.

2	
---	--

	8
--	---

5	
---	--

Dado el número escribe el que va antes y el que va después.

	3	
--	---	--

	6	
--	---	--

	9	
--	---	--

